

ALUTECH SER
CEPHE SİSTEMİ
FACADE SYSTEM

ALUTECH SER
CEPHE SİSTEMLERİ
FACADE SYSTEMS

ÜRÜN TEKNİK ÖZELLİKLERİ
PRODUCT'S TECHNICAL FEATURES

No. Nr.	PROFİL KESİTİ PROFILE VIEW	PROFİL NO PROFILE NO	PROFİL AÇIKLAMASI PROFILE DESCRIPTION	BAĞLANTI PARÇALARI CORNER CLEATS	gr/m	STATİK STATIC			
						Ix cm ⁴	Iy cm ⁴	Wx cm ³	Wy cm ³
1		SER-101 (97,6 - 53) (2 mm)	TAŞIYICI T PROFİL MULLION T PROFILE		935	6	23,74		
2		SER-102 (97,6 - 70) (2 mm)	TAŞIYICI T PROFİL MULLION T PROFILE		1035	13,83	23,75		
3		SER-103 (26,6 - 53) (2 mm)	TAŞIYICI L PROFİL MULLION L PROFILE		479	5,11	0,86		
4		SER-104 (26,6 - 6,8) (1,8 mm)	TAŞIYICI PROFİL MULLION PROFILE		227				
5		SER-105 (38,7 - 19,3) (1,5 mm)	KÖŞE DERZ PROFİL CORNER JOINT PROFILE		312				
6		SER-106 (60 - 42,5) (2,5 mm)	TAŞIYICI T PROFİL MULLION T PROFILE		677	4,04	4,49		
7		SER-107 (80 - 60) (2 mm)	TAŞIYICI T PROFİL MULLION T PROFILE		748	9,30	8,52		
8		SER-108 (70 - 50) (1,8 mm)	TAŞIYICI T PROFİL MULLION T PROFILE		748	9,30	8,52		
9		SER-110 (80 - 50,5) (2,5 mm)	TAŞIYICI T PROFİL MULLION T PROFILE		922	7,12	12,10		
10		SER-111 (80 - 40) (2 mm)	TAŞIYICI T PROFİL MULLION T PROFILE		551	4,77	4,69		

Profil değerleri teoriktir. Ağırlık olarak testimde yapılan tartım geçerlidir.
Profil imatları TS EN 12020-2 ve TS EN 755-9 toleransı,
Moment değerleri EN 14024'e göre hesaplanmıştır.

Profile values are theoretical pre-shipment weight will be valid.
The tolerances of Profile manufacturing are calculated according to EN 12020-2
and TS EN 755-9; moment values are calculated according to EN 14024.

ALUTECH SER
CEPHE SİSTEMLERİ
FACADE SYSTEMS

ÜRÜN TEKNİK ÖZELLİKLERİ
PRODUCT'S TECHNICAL FEATURES

No. Nr.	PROFİL KESİTİ PROFILE VIEW	PROFİL NO PROFILE NO	PROFİL AÇIKLAMASI PROFILE DESCRIPTION	BAĞLANTI PARÇALARI CORNER CLEATS	gr/m	STATİK STATIC			
						Ix cm ⁴	Iy cm ⁴	Wx cm ³	Wy cm ³
11		SER-112 (60 - 40) (1.8 mm)	TAŞIYICI T PROFİL MULLION T PROFILE		447	2,41	2,67		
12		SER-113 (40 - 80) (15 mm)	TAŞIYICI PROFİL MULLION PROFILE		951	10,16	5,08		
13		SER-114 (60 - 50) (1.8 mm)	TAŞIYICI T PROFİL MULLION T PROFILE		505	4,56	2,96		
14		SER-201 (19,2 - 48) (1.8 mm)	KLİPS PROFİL CLIP PROFILE		495				
15		SER-202 (10,5 - 55,1) (2,5 mm)	KLİPS ADAPTÖR PROFİL CLIP ADAPTER PROFILE		432				
16		AG-201 (21,1 - 60) (2 mm)	AGRAF PROFİL AGRAF PROFILE		615				
17		SER-301 (80 - 50) (3 mm)	TAŞIYICI L PROFİL MULLION L PROFILE		1032				
18		SER-302 (120 - 50) (3 mm)	TAŞIYICI L PROFİL MULLION L PROFILE		1357				
19		SER-303 (160 - 50) (3 mm)	TAŞIYICI L PROFİL MULLION L PROFILE		1683				
20									

Profil değerleri teoriktir. Ağırlık olarak testimde yapılan tartım geçerlidir.
Profil imalatları TS EN 12020-2 ve TS EN 755-9 toleransı,
Moment değerleri EN 14024'e göre hesaplanmıştır.

Profile values are theoretical pre-shipment weight will be valid.
The tolerances of Profile manufacturing are calculated according to EN 12020-2
and TS EN 755-9; moment values are calculated according to EN 14024.

ALUTECH SER
CEPHE SİSTEMİ PROFİLLERİ
FAÇADE SYSTEM PROFILE

ÜRÜN TEKNİK ÖZELLİKLERİ
PRODUCT'S TECHNICAL FEATURES

KLİPSLİ SİSTEM
CLIP SYSTEM

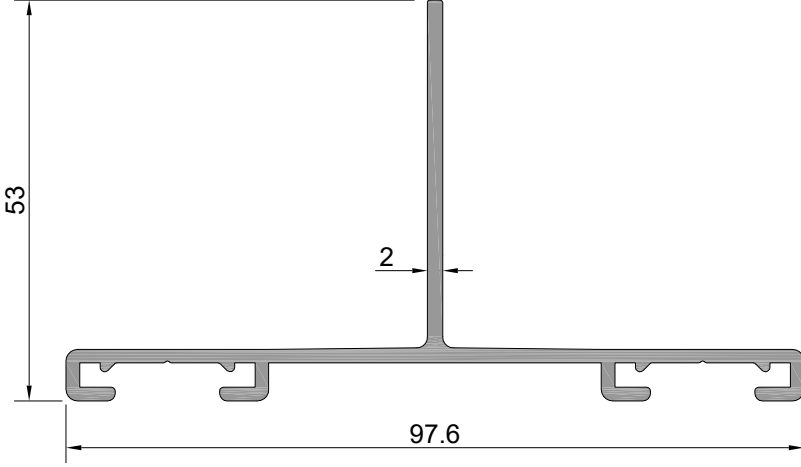

Profil No: SER-101
Ağırlık : 935 gr/m
Ix : 6,00 cm⁴
Iy : 23,74 cm⁴

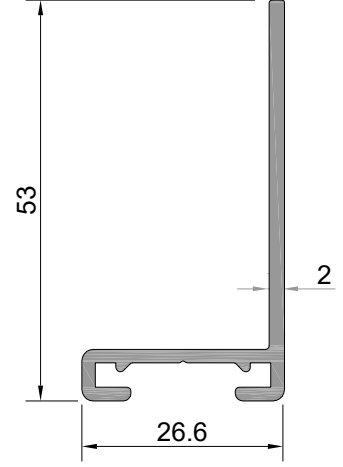

Profil No: SER-103
Ağırlık : 479 gr/m
Ix : 5,11 cm⁴
Iy : 0,86 cm⁴

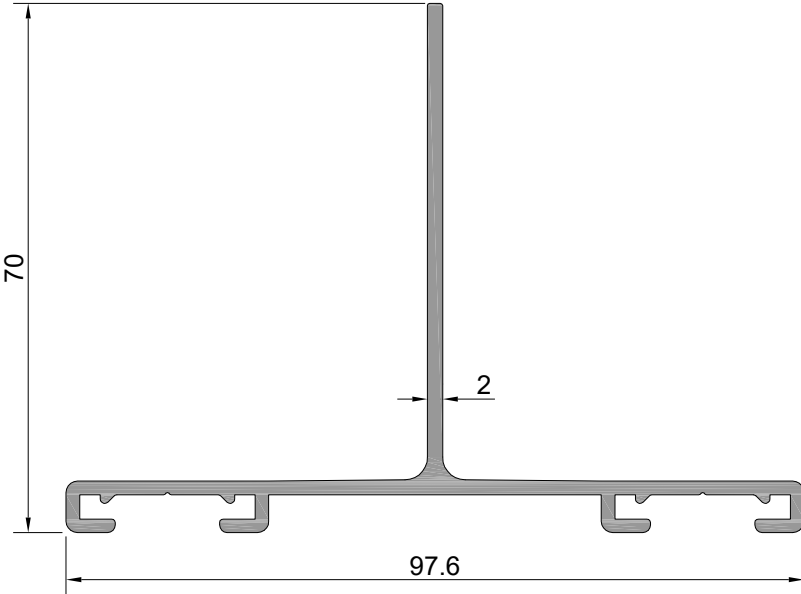

Profil No: SER-102
Ağırlık : 1035 gr/m
Ix : 13,83 cm⁴
Iy : 23,75 cm⁴

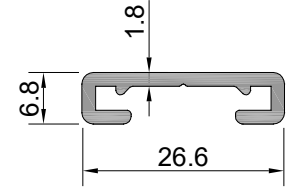

Profil No: SER-104
Ağırlık : 227 gr/m

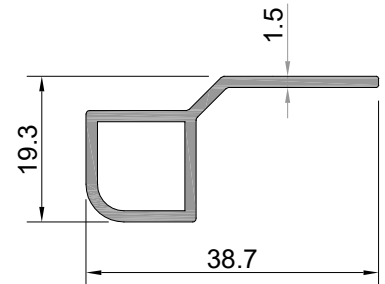

Profil No: SER-105
Ağırlık : 312 gr/m

ALUTECH SER
CEPHE SİSTEMİ
FAÇADE SYSTEM

ÜRÜN TEKNİK ÖZELLİKLERİ
PRODUCT'S TECHNICAL FEATURES

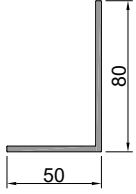

SER-301
Ağırlık:1032 gr/m

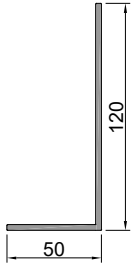
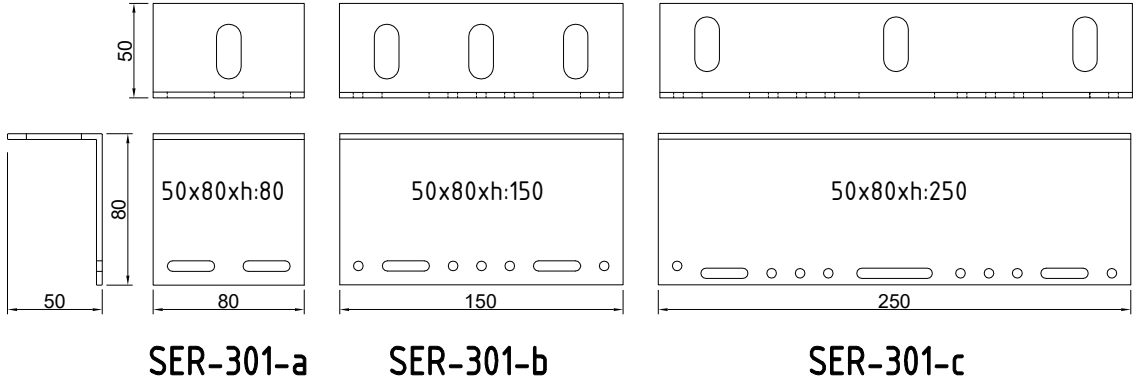

SER-302
ağırlık:1357 gr/m

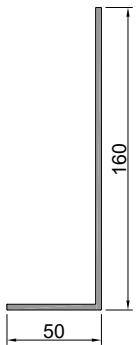
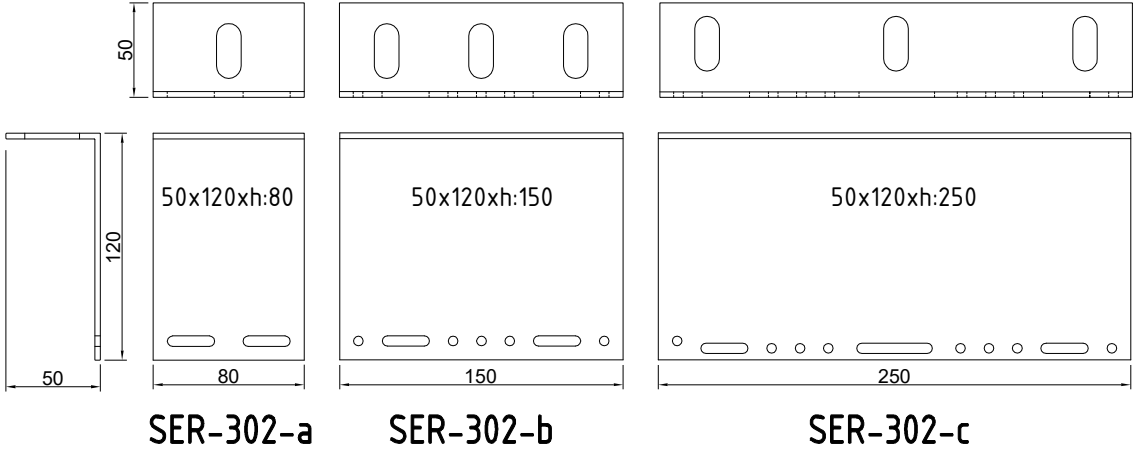

SER-303
ağırlık:1683 gr/m

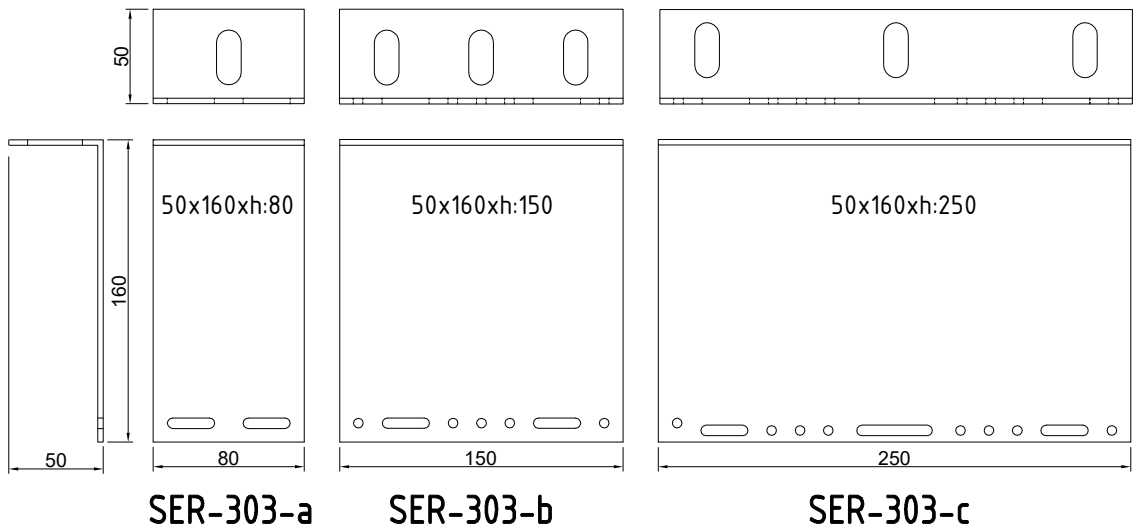

ALUTECH SER
CEPHE SİSTEMİ
FAÇADE SYSTEM

PLAN DETAY
PLAN DETAIL

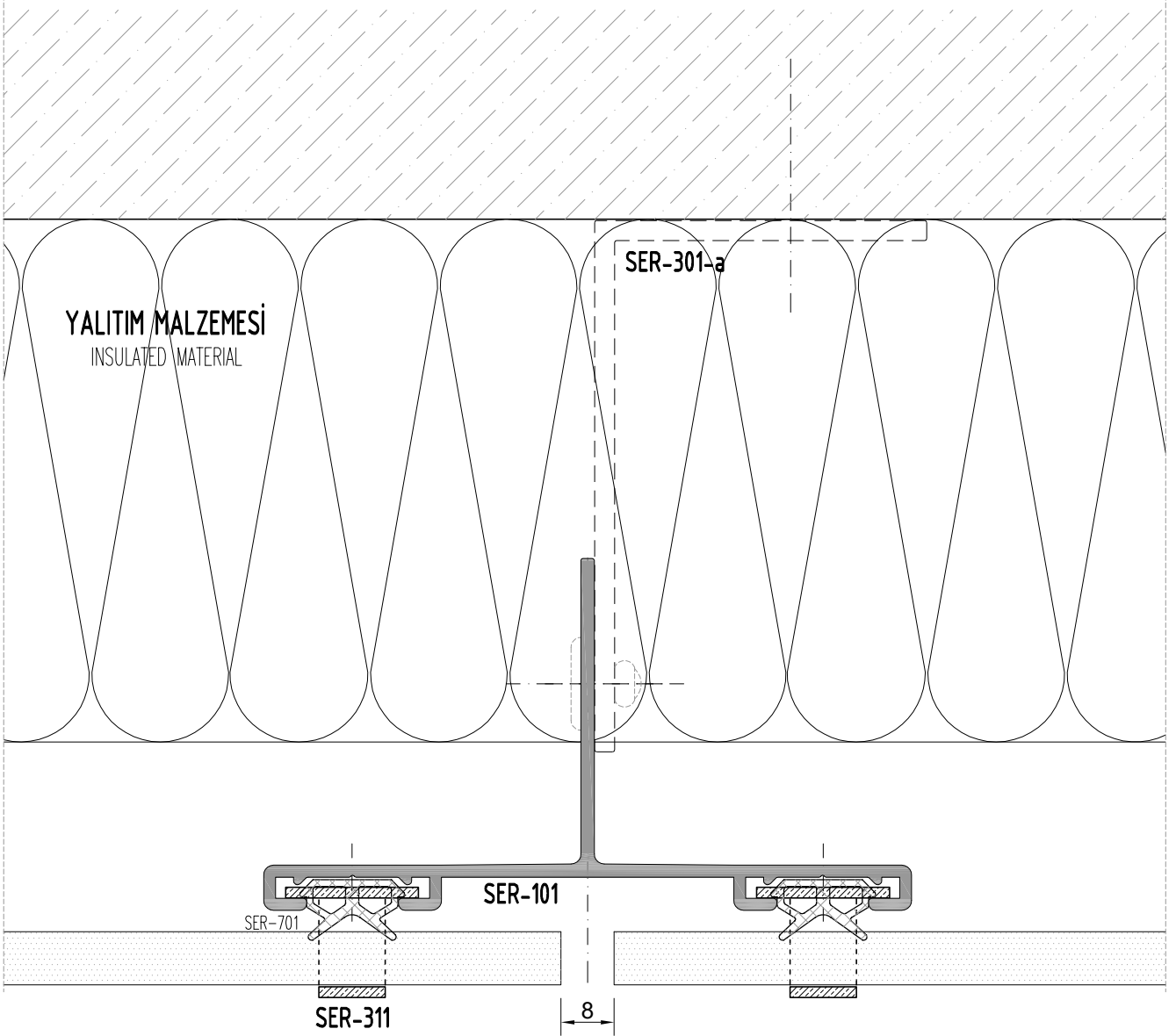
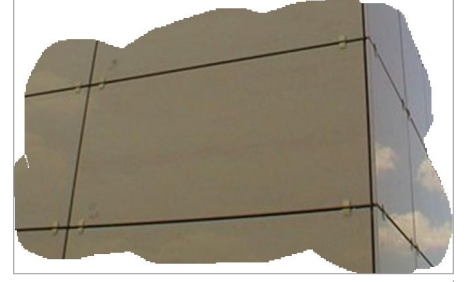

ALUTECH SER
CEPHE SİSTEMİ
FAÇADE SYSTEM

PLAN DETAY
PLAN DETAIL

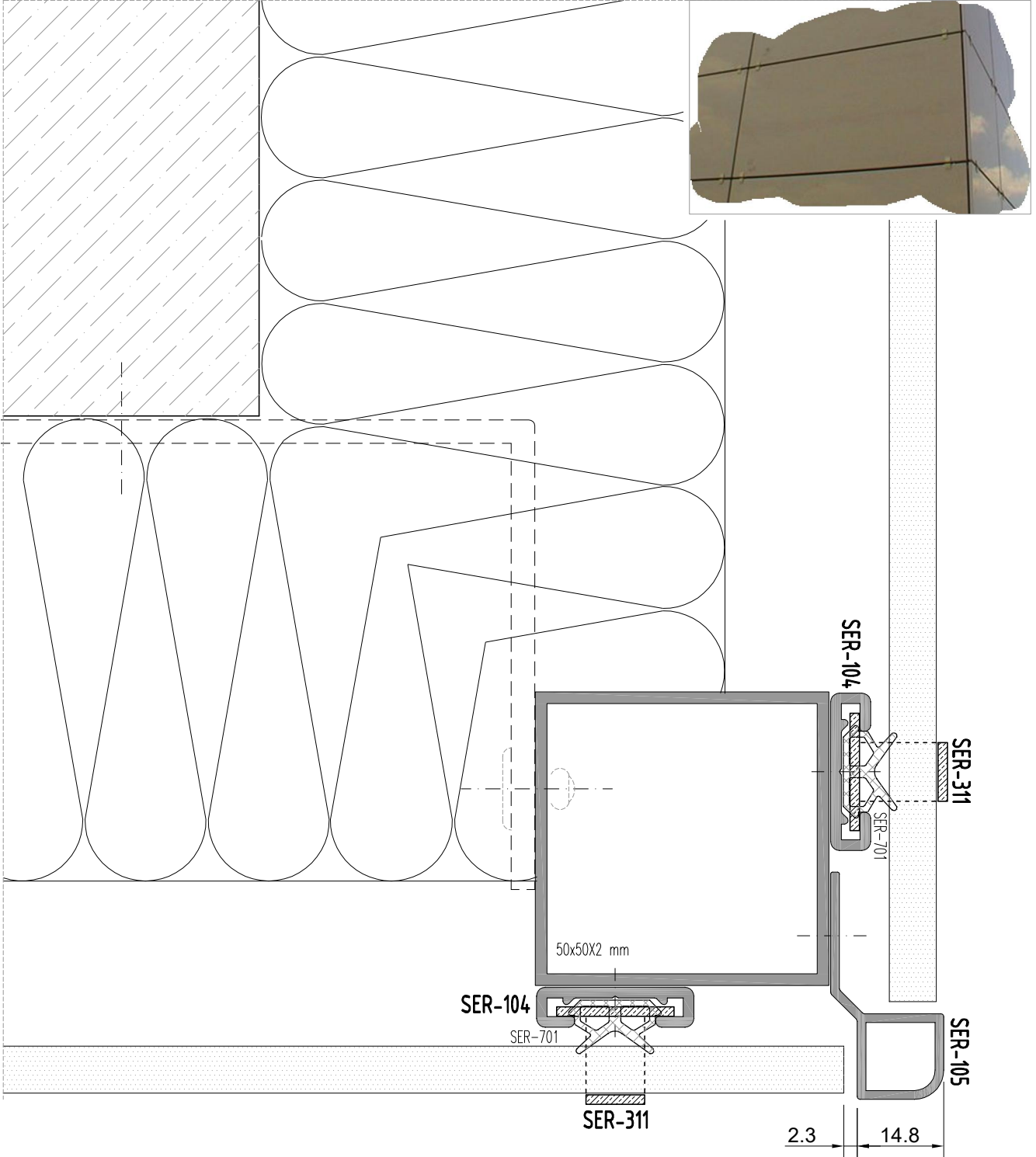

ALUTECH SER
CEPHE SİSTEMİ
FACADE SYSTEM

PLAN DETAY
PLAN DETAIL

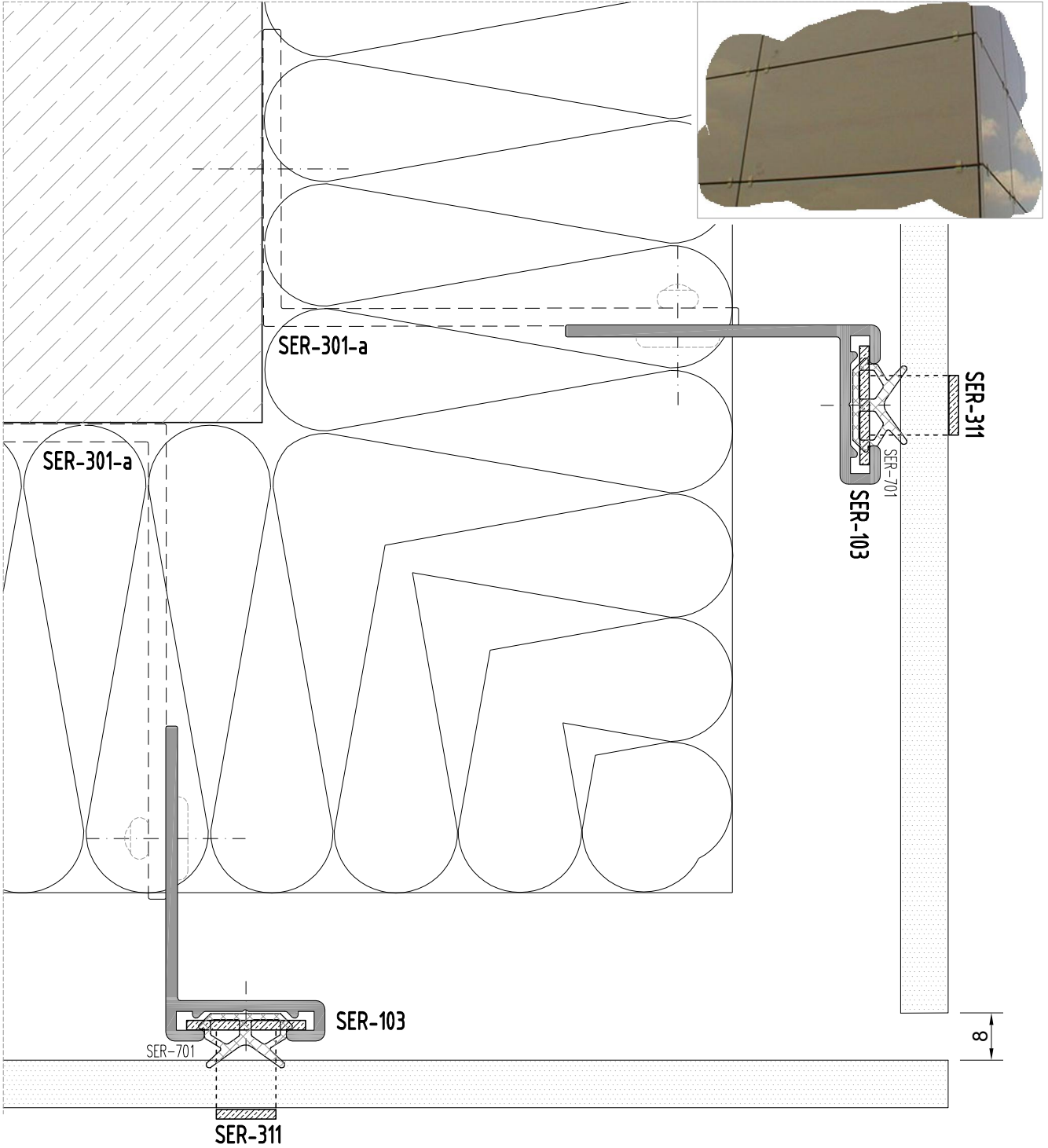

ALUTECH SER
CEPHE SİSTEMİ
FAÇADE SYSTEM

KESİT DETAY
SECTION DETAIL

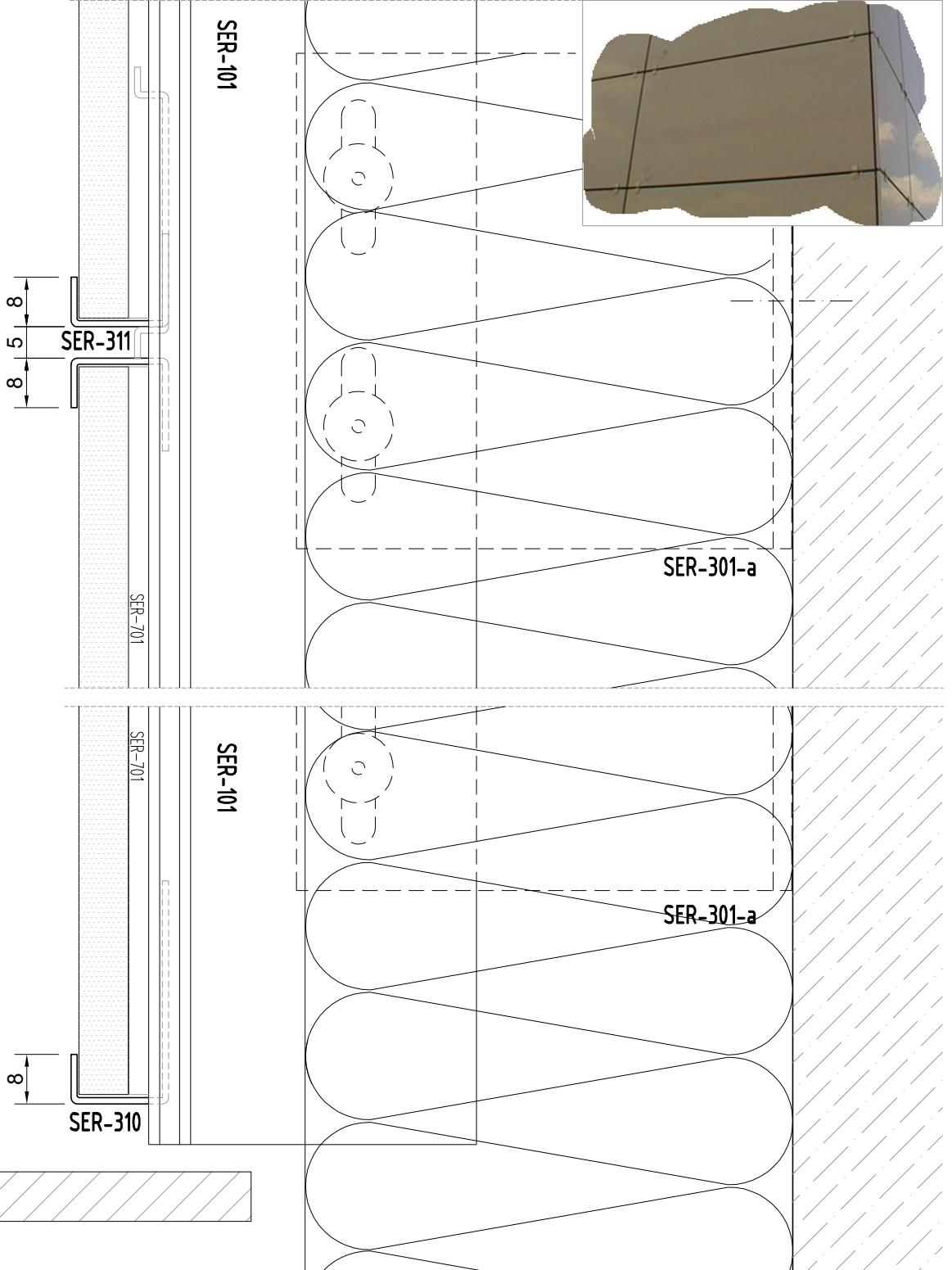

ALUTECH SER
CEPHE SİSTEMİ
FAÇADE SYSTEM

ÜRÜN TEKNİK ÖZELLİKLERİ
PRODUCT'S TECHNICAL FEATURES

ANALİZ ÖRNEĞİ
-30 x 60 cm TAŞ İÇİN ANALİZ
5,05 m² için analiz değerleri alınmıştır.

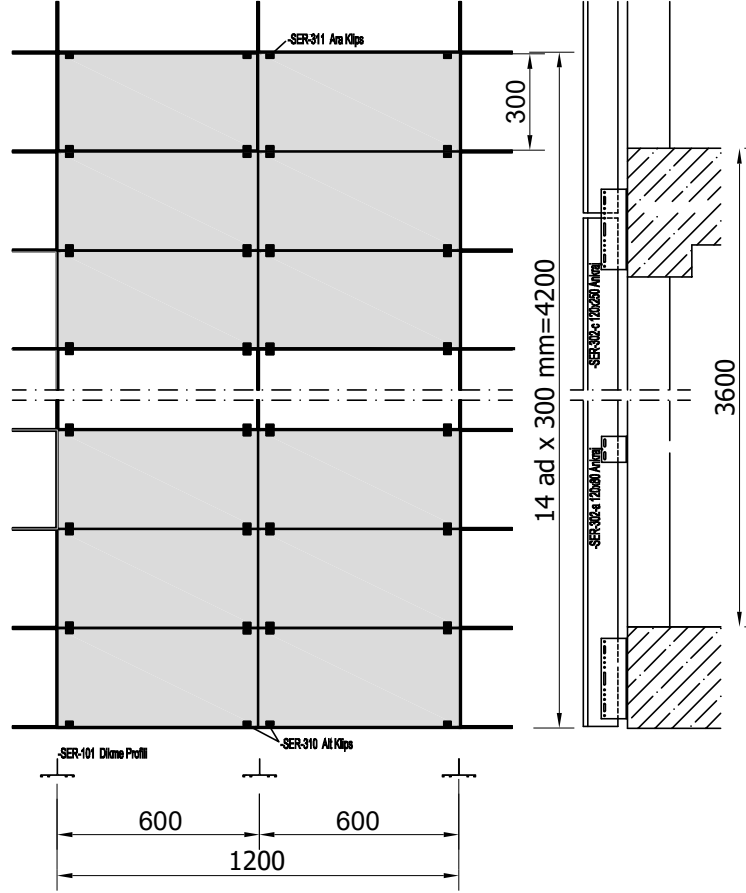

MALZEMENİN CİNSİ	BİRİM	MİKTAR	TOPLAM
-SER-101 Dikme Profili	0,933 kg/mt	12,6 mt ^(4,2x3)	11,76 kg
-SER-302-c 120x250 Ankrāj	3 ad.	1 ad.	3 ad.
-SER-302-a 120x80 Ankrāj	3 ad.	1 ad.	3 ad.
-SER-310 Alt Klips	4 ad.	1 ad.	4 ad.
-SER-311 Ara Klips	4 ad.	28 taş	112 ad-SER-310=104 ad
-SER-312 8mm Fuga Elamanı	2 ad.	28 taş	56 ad.
-4,8x15 mm Geniş Kafa Pop Perçin (Ankrajlarda Kullanılır.)	SER-302-c 3x3:9ad. SER-302-a 3x1:3ad.	9+3	12 ad.
-4,0x10mm Alü. Pop Perçin	SER-310+SER312	4+56	60 ad.
-Çelik dübel (paslanmaz)	SER-302-c 3x3:9ad. SER-302-a 3x1:3ad.	9+3	12 ad.
-SER-701 EPDM Fital (0.65gr)	12.6 mt	2 sıra ^(4,6x3)	25.20 mt

ALUTECH SER
CEPHE SİSTEMİ PROFİLLERİ
FAÇADE SYSTEM PROFILE

ÜRÜN TEKNİK ÖZELLİKLERİ
PRODUCT'S TECHNICAL FEATURES

ZIKOV SİSTEM
ZIKOV SYSTEM

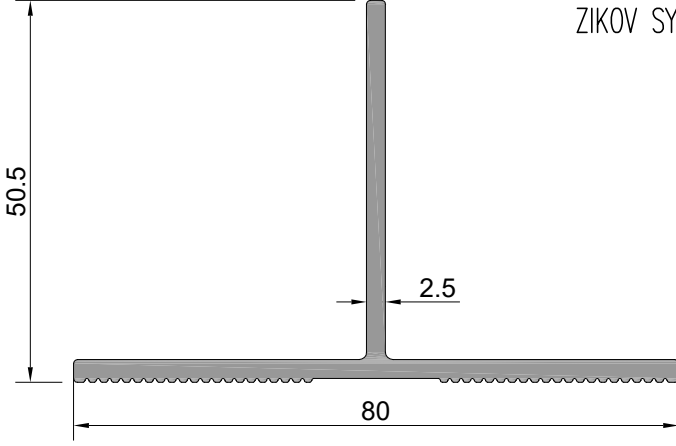

Profil No: SER-110
Ağırlık : 922 gr/m
lx : 7,12 cm⁴
ly : 12,10 cm⁴

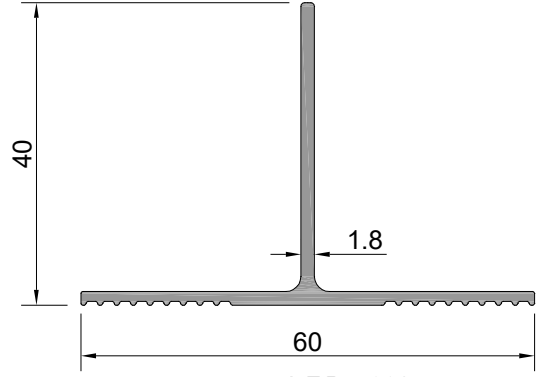

Profil No: SER-112
Ağırlık : 447 gr/m
lx : 2,41 cm⁴
ly : 2,67 cm⁴

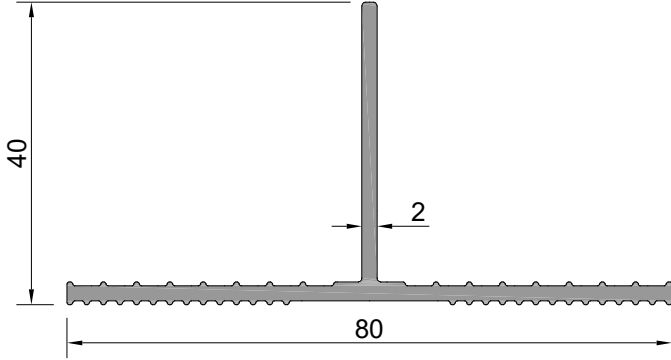

Profil No: SER-111
Ağırlık : 689 gr/m
lx : 2,94 cm⁴
ly : 9,64 cm⁴

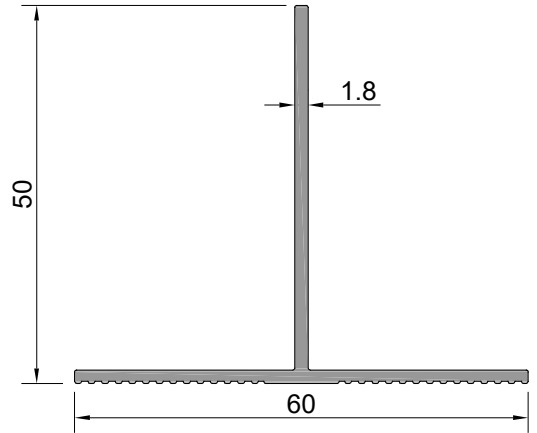

Profil No: SER-114
Ağırlık : 504 gr/m
lx : 4,57 cm⁴
ly : 2,96 cm⁴

ALUTECH SER
CEPHE SİSTEMİ PROFİLLERİ
FAÇADE SYSTEM PROFILE

ÜRÜN TEKNİK ÖZELLİKLERİ
PRODUCT'S TECHNICAL FEATURES

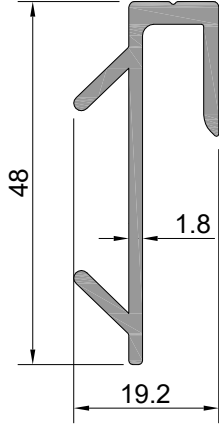

Profil No: SER-201
Ağırlık : 495 gr/m

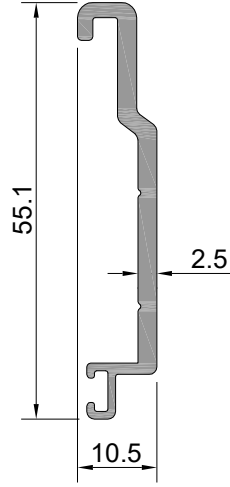

Profil No: SER-202
Ağırlık : 432 gr/m

SER-201-a	50 mm	100 adet/pcs
-----------	-------	--------------

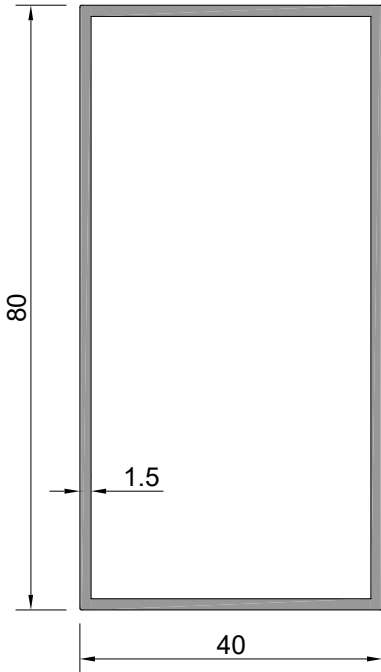

Profil No: SER-113
Ağırlık : 951 gr/m
Ix : 10,16 cm⁴
Iy : 29,89 cm⁴

ALUTECH SER
CEPHE SİSTEMİ
FAÇADE SYSTEM

PLAN VE KESİT DETAY
PLAN AND SECTION DETAIL

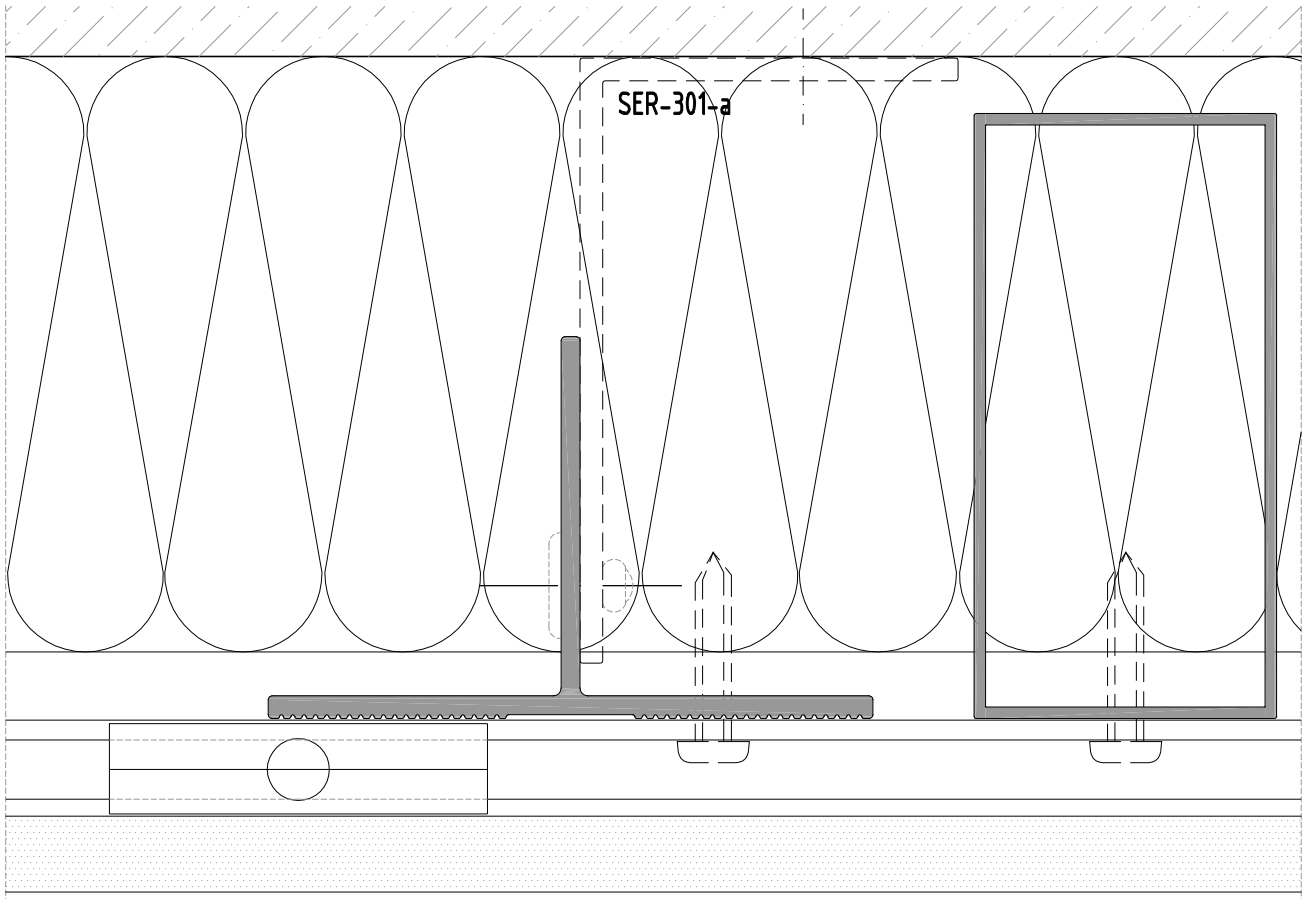
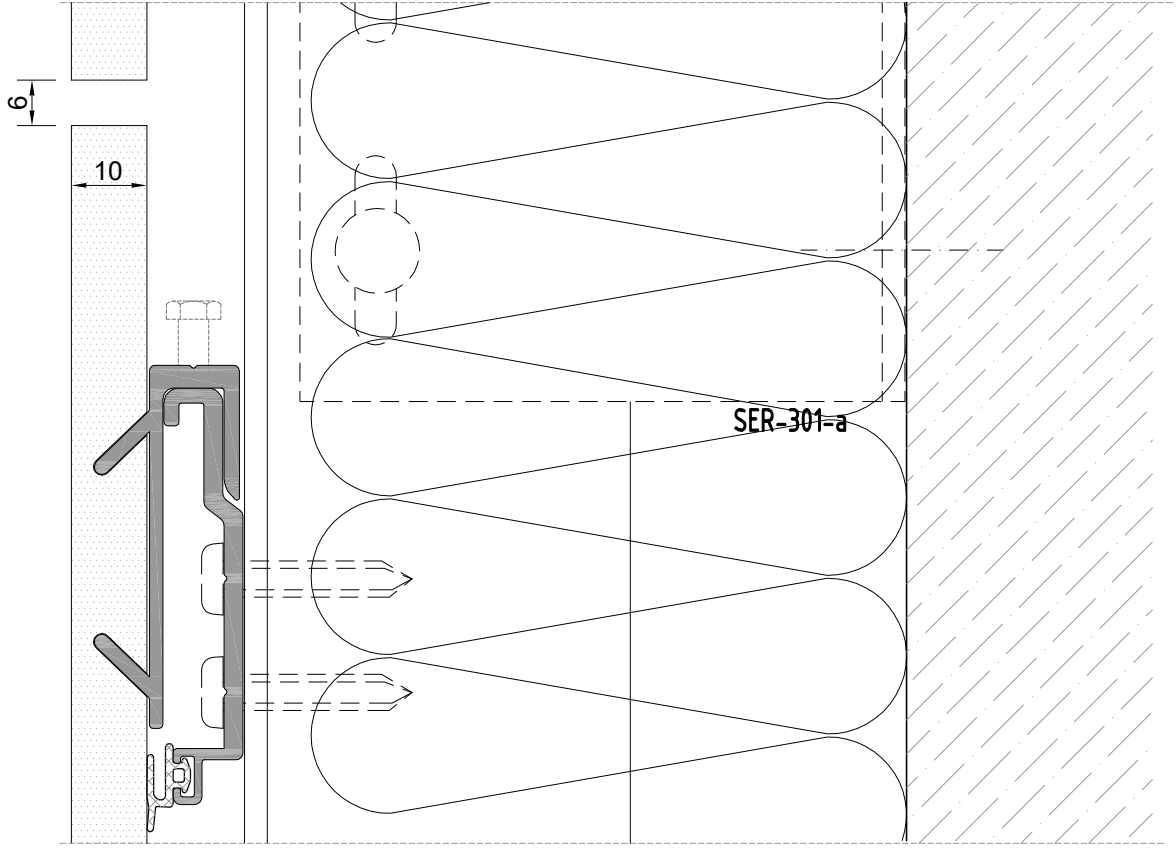

Profil değerleri teoriktir. Ağırlık olarak testimde yapılan tartım geçerlidir.
Profil imalatları TS EN 12020-2 ve TS EN 755-9 toleransı,
Moment değerleri EN 14024'e göre hesaplanmıştır.

Profile values are theoretical pre-shipment weight will be valid.
The tolerances of Profile manufacturing are calculated according to EN 12020-2
and TS EN 755-9; moment values are calculated according to EN 14024.

ALUTECH SER
CEPHE SİSTEMİ
FAÇADE SYSTEM

ÜRÜN TEKNİK ÖZELLİKLERİ
PRODUCT'S TECHNICAL FEATURES

AGRAF SİSTEM
AGRAF SYSTEM

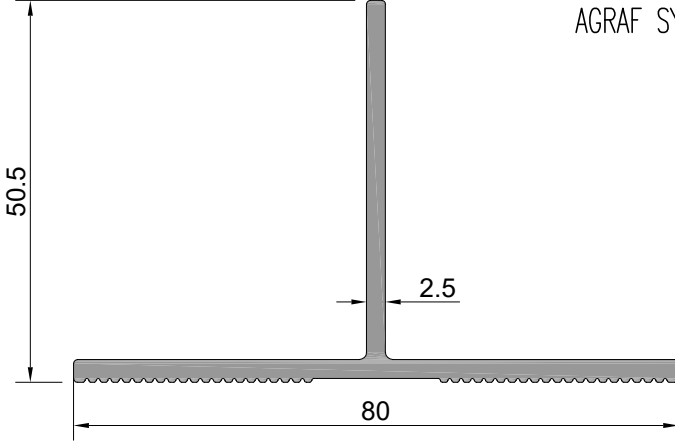

Profil No: SER-110
Ağırlık : 922 gr/m
Ix : 7,12 cm⁴
Iy : 12,10 cm⁴

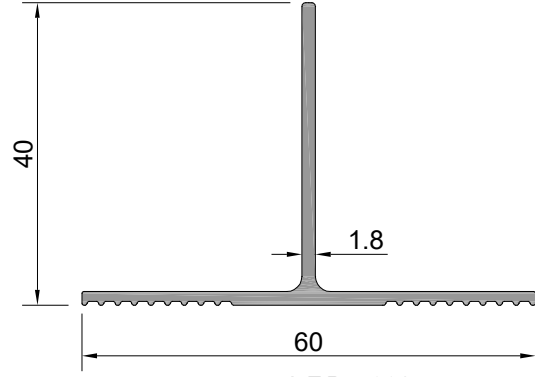

Profil No: SER-112
Ağırlık : 447 gr/m
Ix : 2,41 cm⁴
Iy : 2,67 cm⁴

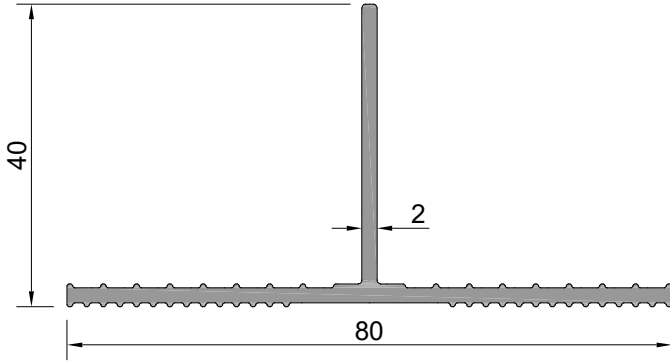

Profil No: SER-111
Ağırlık : 689 gr/m
Ix : 2,94 cm⁴
Iy : 9,64 cm⁴

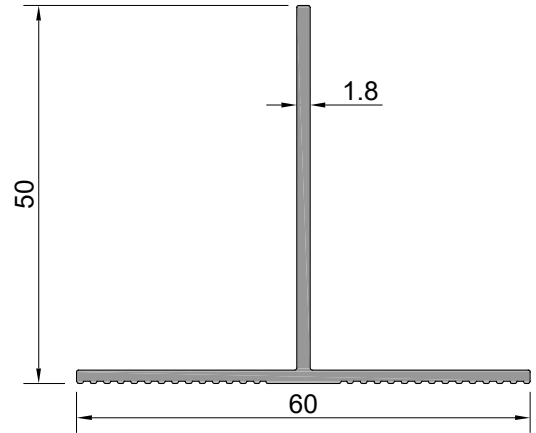

Profil No: SER-114
Ağırlık : 505 gr/m
Ix : 4,57 cm⁴
Iy : 2,96 cm⁴

ALUTECH SER
CEPHE SİSTEMİ
FAÇADE SYSTEM

ÜRÜN TEKNİK ÖZELLİKLERİ
PRODUCT'S TECHNICAL FEATURES

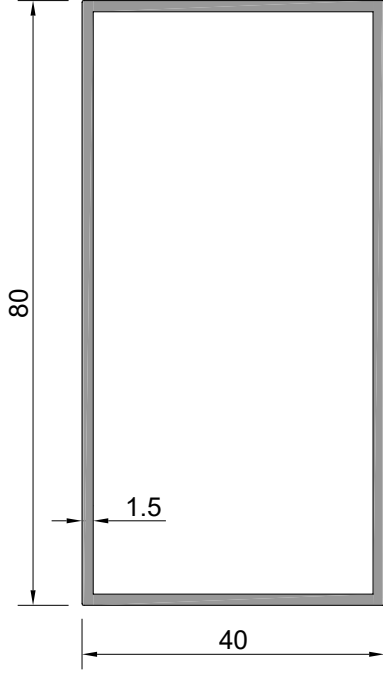

Profil No: SER-113
Ağırlık : 951 gr/m
lx : 10,16 cm⁴
ly : 29.89 cm⁴

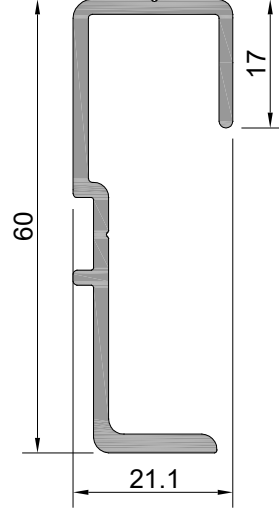

Profil No: AG-201
Ağırlık : 615 gr/m

AG-201-a	50 mm	100 adet/pcs
----------	-------	--------------

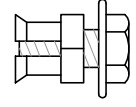

Profil No: AG-301
özel insert civata

ALUTECH SER
CEPHE SİSTEMİ
FACADE SYSTEM

PLAN VE KESİT DETAY
PLAN AND SECTION DETAIL

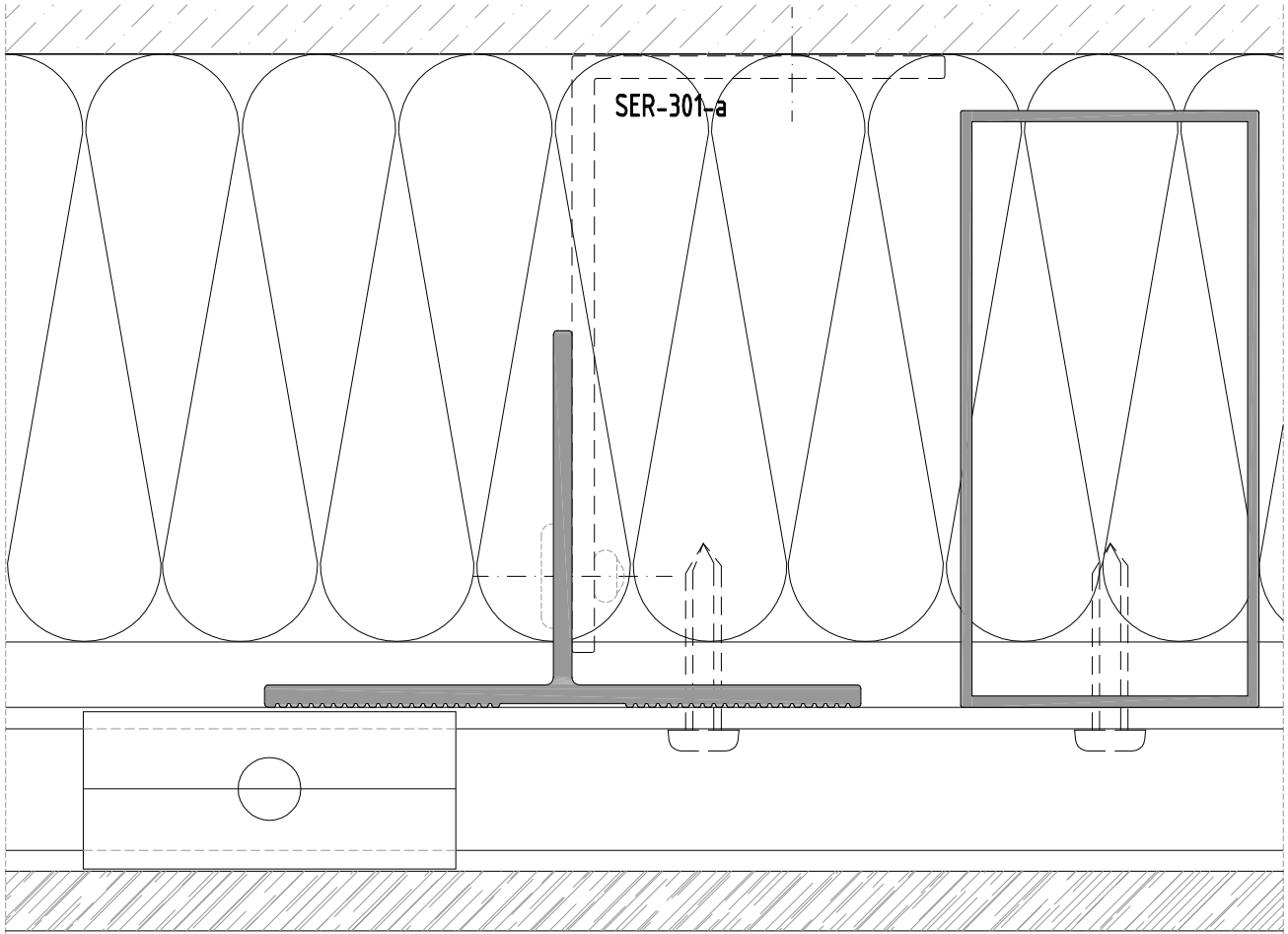
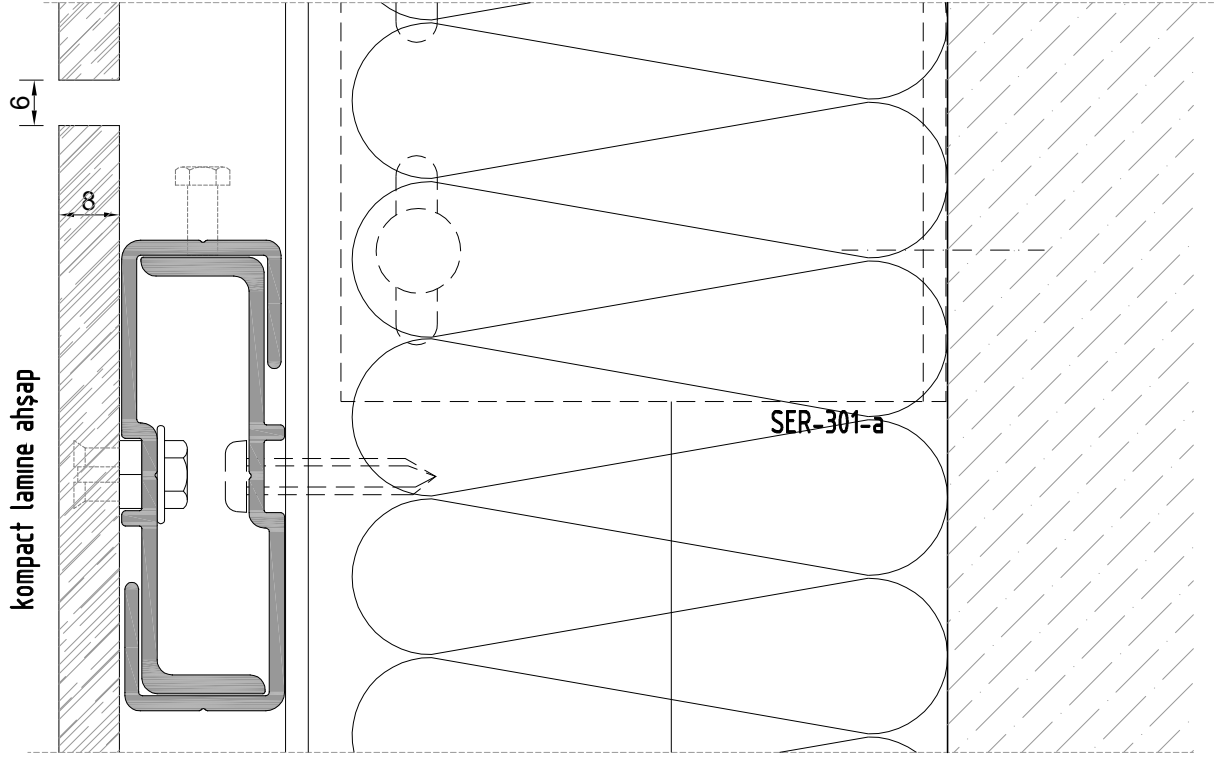

ALUTECH SER
CEPHE SİSTEMİ
FAÇADE SYSTEM

ÜRÜN TEKNİK ÖZELLİKLERİ
PRODUCT'S TECHNICAL FEATURES

YAPIŞTIRMA SİSTEM
BONDING SYSTEM

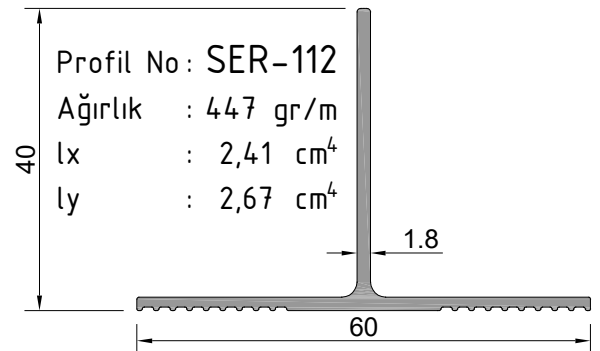
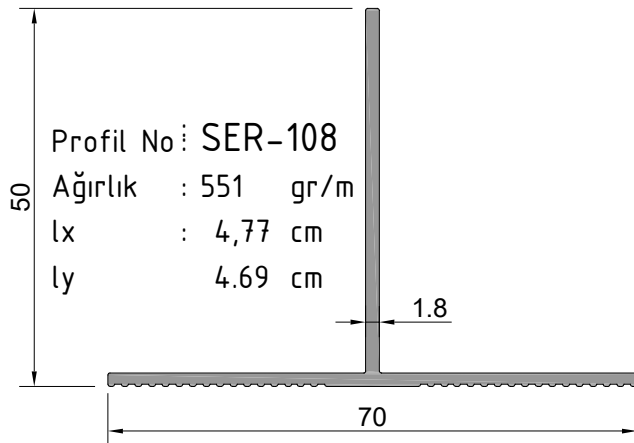
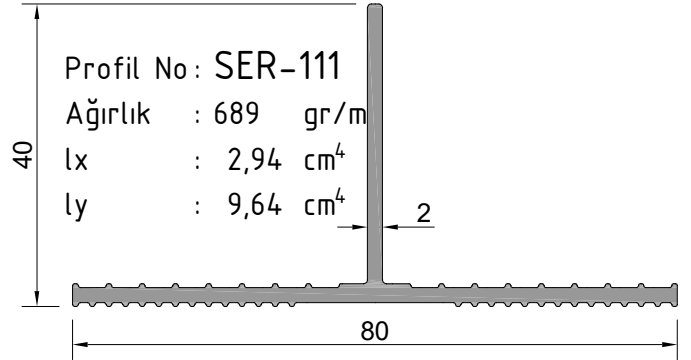
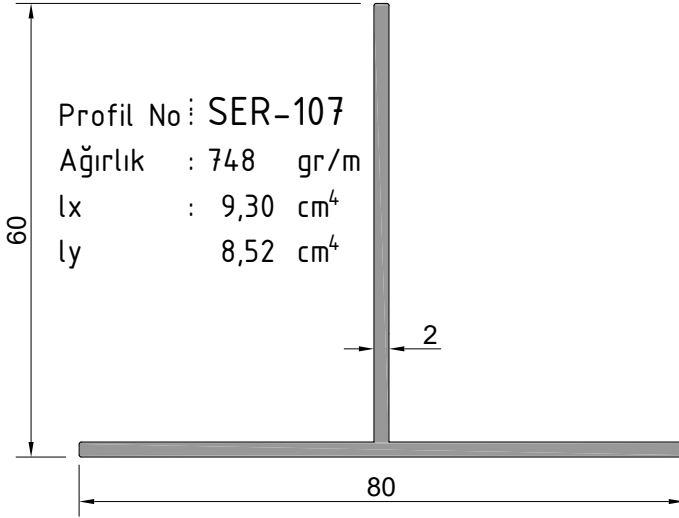
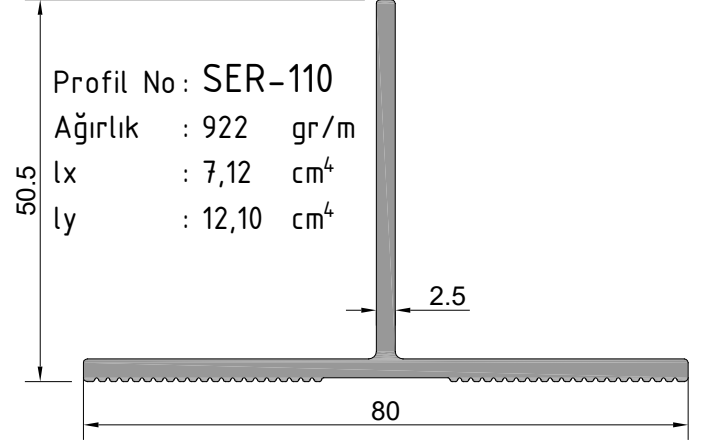
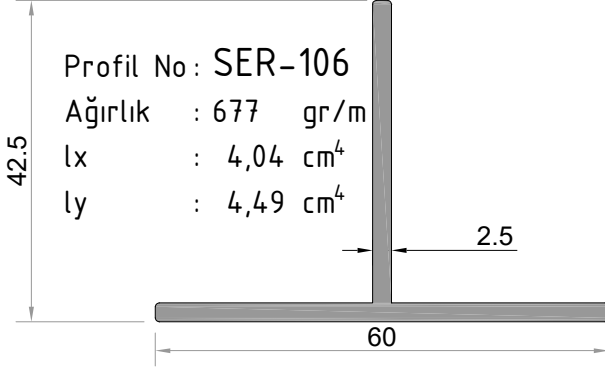

ALUTECH SER
CEPHE SİSTEMİ
FACADE SYSTEM

PLAN VE KESİT DETAY
PLAN AND SECTION DETAIL

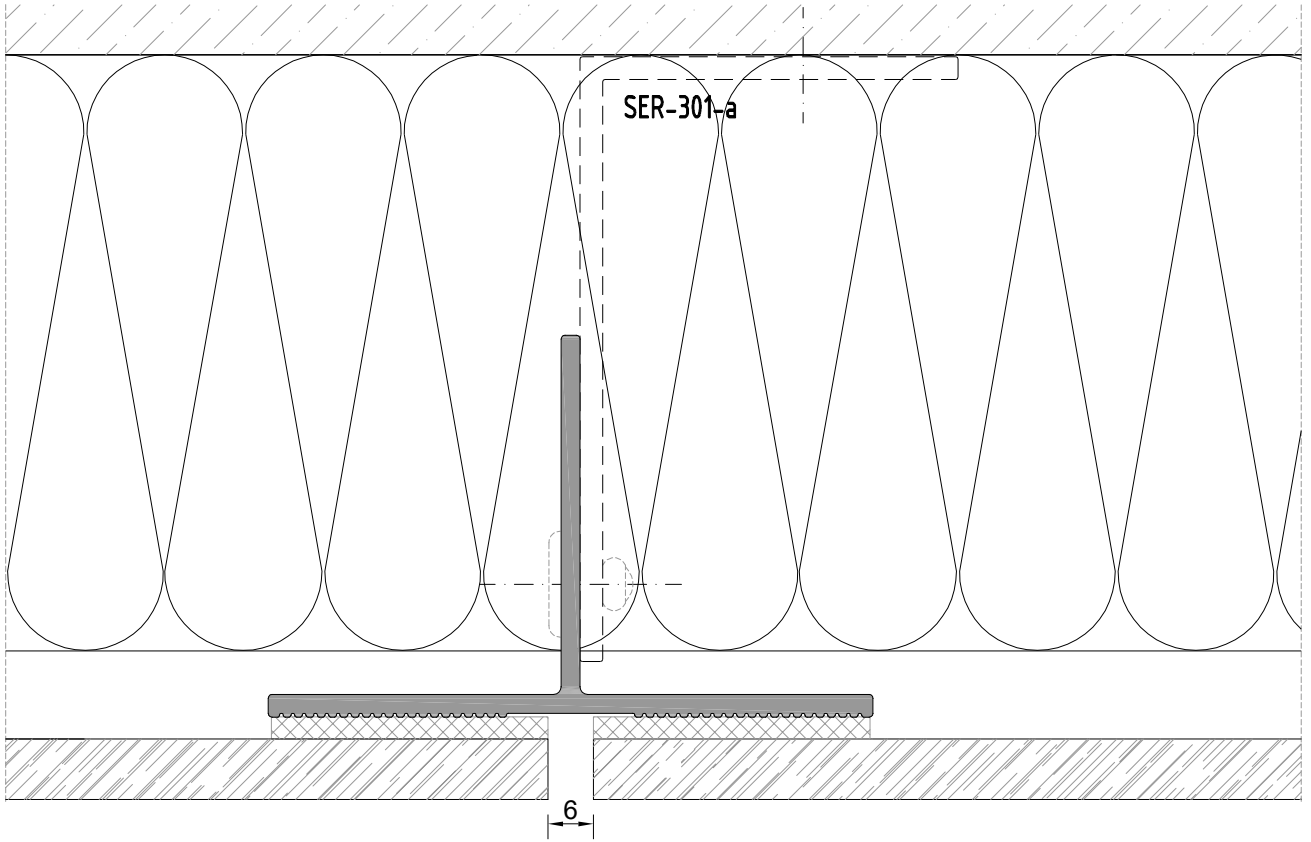
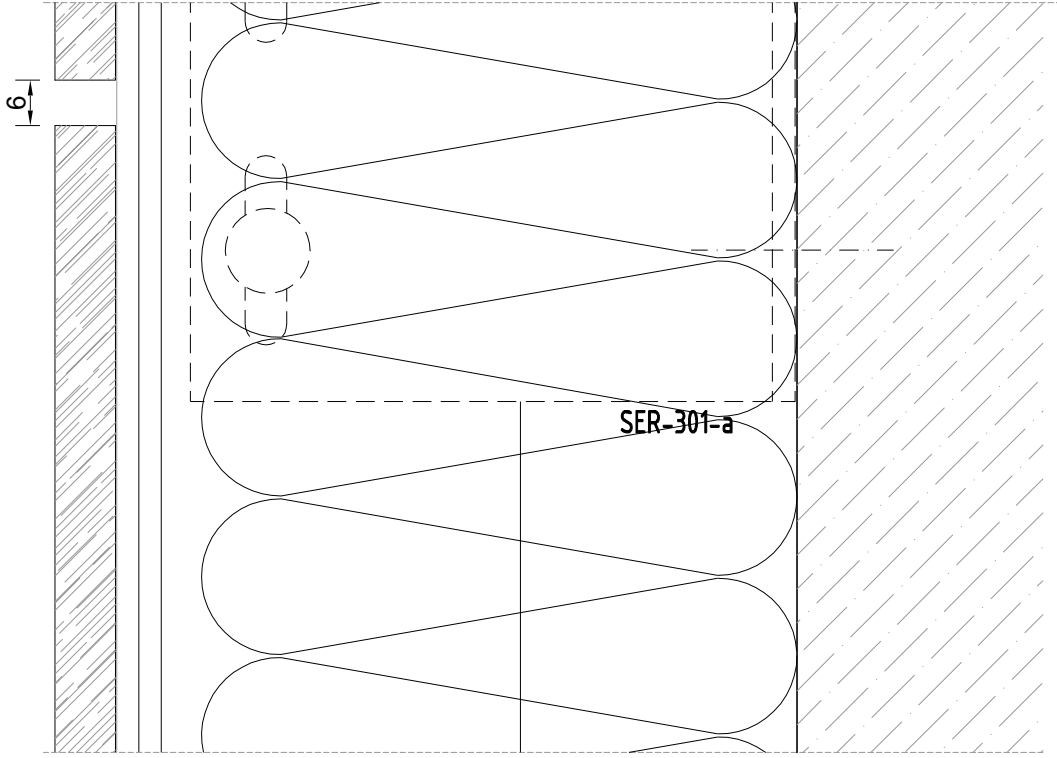

ALUTECH SER CEPHE SİSTEMİ PROFİLLERİ FAÇADE SYSTEM PROFILE

KLİPSLİ SİSTEM ÜRÜN TEKNİK ÖZELLİKLERİ
CLIP SYSTEM PRODUCT'S TECHNICAL FEATURES

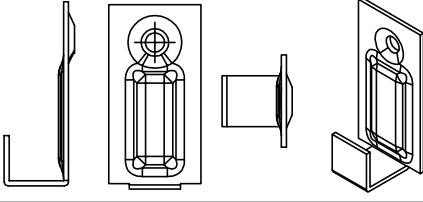

SER-310

ALT KLİPS (Taş tutturma (alt başlangıç) tırnağı)
304 Kalite Paslanmaz Çelik 1.2 mm, talepedilen RAL kodunda boyanır.

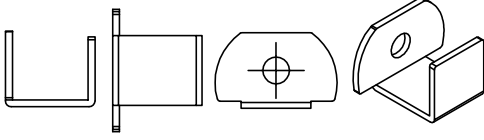

SER-311

ARA KLİPS (Taş tutturma ara tırnak)
304 Kalite Paslanmaz Çelik 1.2 mm, talepedilen RAL kodunda boyanır.
8-9-10-11 mm Taşlar için

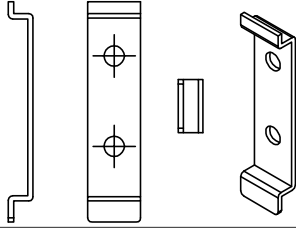

SER-312

FUGA ELAMANI (Derz ayar parçası)
304 Kalite Paslanmaz Çelik 1.2 mm, Siyah boyalı
6-8 mm Derz için



SER-313

45° DERZ AYAR PARÇASI
304 Kalite Paslanmaz Çelik 1.2 mm, Siyah boyalı
8 mm derz için

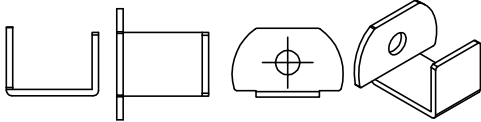

SER-314

ARA KLİPS (Taş tutturma ara tırnak)
304 Kalite Paslanmaz Çelik 1.2 mm, talepedilen RAL kodunda boyanır.
11-12 mm Taşlar için

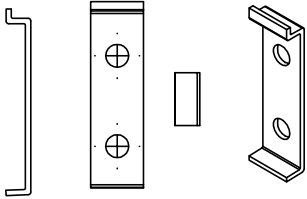

SER-315

FUGA ELAMANI (Derz ayar parçası)
304 Kalite Paslanmaz Çelik 1.2 mm, Siyah boyalı
4-6 mm Derz için

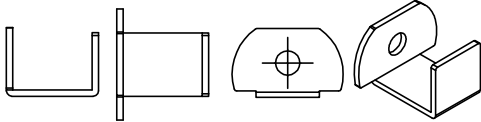

SER-316

ARA KLİPS (Taş tutturma ara tırnak)
304 Kalite Paslanmaz Çelik 1.2 mm, talepedilen RAL kodunda boyanır.
15-16 mm Taşlar için

SER-701

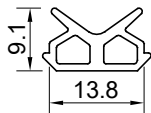

taşıyıcı çarpma fitil
mullion acoustical (epdm)

70 gr/m

15 kg
(kutda)

214 m
(kutda)