

ALUTECH COTTA CEPHE SISTEMI
ALUTECH COTTA FACADE SYSTEM















ALUTECH COTTA
CEPHE SISTEMI
FACADE SYSTEM

ALUTECH COTTA

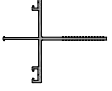
CEPHE SİSTEMİ

FAÇADE SYSTEM

ÜRÜN TEKNİK ÖZELLİKLERİ
PRODUCT'S TECHNICAL FEATURES

No. Nr.	PROFİL KESİTİ PROFILE VIEW	PROFİL NO PROFILE NO	PROFİL AÇIKLAMASI PROFILE DESCRIPTION	BAĞLANTI PARÇALARI CORNER CLEATS	gr/m	STATİK STATIC			
						I_x cm ⁴	I_y cm ⁴	W_x cm ³	W_y cm ³
1		COT-101 (64 - 37.4) (12 mm)	TAŞIYICI PROFİL MULLION PROFILE		600	8.47	1.08		
2	  İşaretili profil için satış ekibinden bilgi alınız.	COT-102 (48.7 - 37.4) (12 mm)	TAŞIYICI PROFİL MULLION PROFILE		489	5.04	0.94		
3	  İşaretili profil için satış ekibinden bilgi alınız.	COT-103 (18.8 - 17) (1 mm)	TAŞIYICI ADAPTÖR PROFİL MULLION ADAPTER PROFILE		138				
4		COT-104 (24.5 - 56.5) (15 mm)	TAŞIYICI PROFİL MULLION PROFILE		434	0.85	2.84		
5	  İşaretili profil için satış ekibinden bilgi alınız.	COT-105 (71.8 - 31.7)	TAŞIYICI ANKRAJ PROFİL MULLION PROFILE		574				
6	  İşaretili profil için satış ekibinden bilgi alınız.	COT-106 (71.8 - 61.1)	TAŞIYICI ANKRAJ PROFİL MULLION PROFILE		789				
7		COT-201 (147.8 - 17.4) (15 mm)	PANEL PROFİL PANEL PROFILE		734				
8		COT-202 (177.8 - 17.4) (17 mm)	PANEL PROFİL PANEL PROFILE		962				
9		COT-203 (227.8 - 17.4) (19 mm)	PANEL PROFİL PANEL PROFILE		1327				
10		COT-204 (147.8 - 17.4) (17 mm)	PANEL PROFİL PANEL PROFILE		1053				

Profil değerleri teoriktir. Ağırlık olarak testimde yapılan tartım geçerlidir.
Profil imalatları TS EN 12020-2 ve TS EN 755-9 toleransı,
Moment değerleri EN 14024'e göre hesaplanmıştır.











Profile values are theoretical pre-shipment weight will be valid.
The tolerances of Profile manufacturing are calculated according to EN 12020-2
and TS EN 755-9; moment values are calculated according to EN 14024.

ALUTECH COTTA

CEPHE SİSTEMİ

FACADE SYSTEM

ÜRÜN TEKNİK ÖZELLİKLERİ
PRODUCT'S TECHNICAL FEATURES

No. Nr.	PROFİL KESİTİ PROFILE VIEW	PROFİL NO PROFILE NO	PROFİL AÇIKLAMASI PROFILE DESCRIPTION	BAĞLANTI PARÇALARI CORNER CLEATS	gr/m	STATİK STATIC			
						Ix cm ⁴	Iy cm ⁴	Wx cm ³	Wy cm ³
11	 <small>İşaretili profil için satış ekibinden bilgi alınır.</small>	COT-205 (147.8 - 17.4) (1.7 mm)	PANEL PROFİL PANEL PROFILE		1034				
12		COT-206 (147.8 - 17.4) (1.7 mm)	PANEL PROFİL PANEL PROFILE		953				
13		COT-207 (147.8 - 17.4) (1.7 mm)	PANEL PROFİL PANEL PROFILE		917				
14	 <small>İşaretili profil için satış ekibinden bilgi alınır.</small>	COT-208 (147.8 - 17.3) (1.7 mm)	PANEL PROFİL PANEL PROFILE		912				
15		COT-209 (147.8 - 17.4) (1.7 mm)	PANEL PROFİL PANEL PROFILE		1038				
16		COT-210 (77.8 - 40.4) (1.5 mm)	PANEL PROFİL PANEL PROFILE		547				
17		COT-211 (147.8 - 40.4) (1.5 mm)	PANEL PROFİL PANEL PROFILE		902				
18		COT-212 (187.8 - 40.4) (1.6 mm)	PANEL PROFİL PANEL PROFILE		1206				
19	 <small>ölçeksiz not to scale</small>	COT-213 (229.8 - 17.9) (2.2 mm)	PANEL PROFİL PANEL PROFILE		1572				
20	 <small>İşaretili profil için satış ekibinden bilgi alınır. ölçeksiz not to scale</small>	COT-214 (280.1 - 17.9) (2.5 mm)	PANEL PROFİL PANEL PROFILE		2101				

Profil değerleri teoriktir. Ağırlık olarak testimde yapılan tartım geçerlidir.
Profil imatları TS EN 12020-2 ve TS EN 755-9 toleransı,
Moment değerleri EN 14024'e göre hesaplanmıştır.

Profile values are theoretical pre-shipment weight will be valid.
The tolerances of Profile manufacturing are calculated according to EN 12020-2
and TS EN 755-9; moment values are calculated according to EN 14024.

ALUTECH COTTA
CEPHE SİSTEMİ
FACADE SYSTEM

ÜRÜN TEKNİK ÖZELLİKLERİ
PRODUCT'S TECHNICAL FEATURES

No. Nr.	PROFİL KESİTİ PROFILE VIEW	PROFİL NO PROFILE NO	PROFİL AÇIKLAMASI PROFILE DESCRIPTION	BAĞLANTI PARÇALARI CORNER CLEATS	gr/m	STATİK STATIC			
						Ix cm ⁴	Iy cm ⁴	Wx cm ³	Wy cm ³
21		COT-301 (30 - 21) (15 mm)	KÖŞE ADAPTÖR PROFİL CORNER ADAPTER PROFILE		275				
22		COT-302 (35.3 - 12.7) (16 mm)	KÖŞE ADAPTÖR PROFİL CORNER ADAPTER PROFILE		223				
23		COT-303 (19.5 - 15.3) (1 mm)	KOMPOZİT ADAPTÖR PROFİL COMPOSITE ADAPTER PROFILE		157				
24		COT-304 (21.0 - 30.0) (15 mm)	KÖŞE DÖNÜŞ PROFİLİ CORNER PROFILE		245				
25		COT-305 (17.9 - 49.9) (15 mm)	COTTA BAŞLANGIÇ PROFİLİ COTTA PROFILE		356				
26		SER-301 (80 - 50) (3 mm)	TAŞIYICI L PROFİL MULLION L PROFILE		1032				
27		SER-302 (120 - 50) (3 mm)	TAŞIYICI L PROFİL MULLION L PROFILE		1357				
28		SER-303 (160 - 50) (3 mm)	TAŞIYICI L PROFİL MULLION L PROFILE		1683				
29									
30									

Profil değerleri teoriktir. Ağırlık olarak testimde yapılan tartım geçerlidir.
Profil imalatları TS EN 12020-2 ve TS EN 755-9 toleransı,
Moment değerleri EN 14024'e göre hesaplanmıştır.

Profile values are theoretical pre-shipment weight will be valid.
The tolerances of Profile manufacturing are calculated according to EN 12020-2
and TS EN 755-9; moment values are calculated according to EN 14024.

ALUTECH COTTA CEPHE SİSTEMİ PROFİLLERİ FACADE SYSTEM PROFILE

ÜRÜN TEKNİK ÖZELLİKLERİ
PRODUCT'S TECHNICAL FEATURES

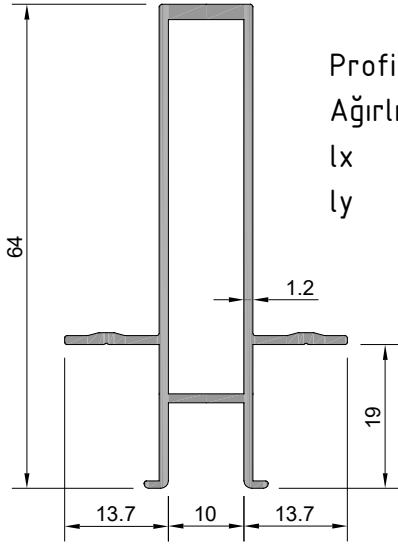

Profil No : COT-101
Ağırlık : 600 gr/m
lx : 8,47 cm⁴
ly : 1,08 cm⁴

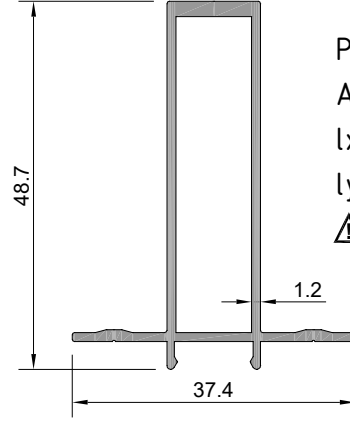

Profil No : COT-102 ⚠
Ağırlık : 489 gr/m
lx : 5,04 cm⁴
ly : 0,94 cm⁴

⚠ İşaretti profil için satış ekibinden bilgi alınır.

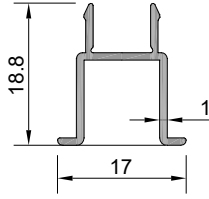

Profil No : COT-103 ⚠
Ağırlık : 138 gr/m

⚠ İşaretti profil için satış ekibinden bilgi alınır.

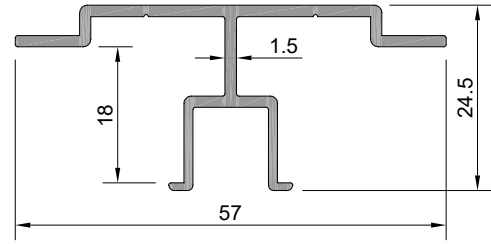

Profil No : COT-104
Ağırlık : 434 gr/m
lx : 0,85 cm⁴
ly : 2,84 cm⁴

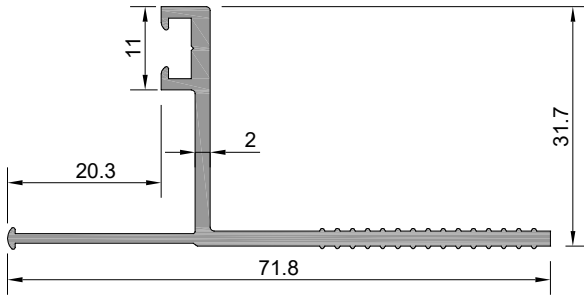

Profil No : COT-105 ⚠
Ağırlık : 574 gr/m

⚠ İşaretti profil için satış ekibinden bilgi alınır.

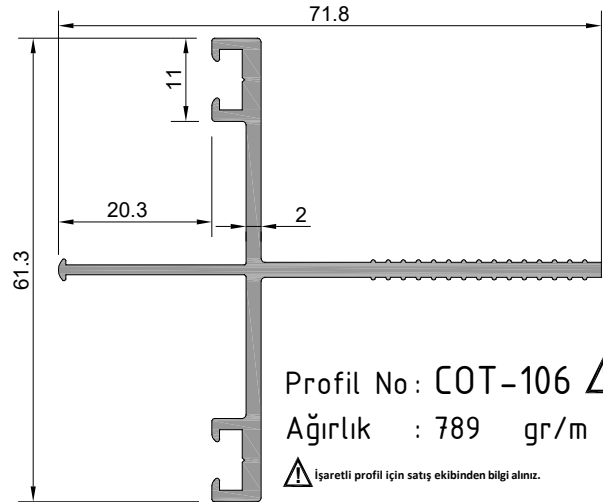

Profil No : COT-106 ⚠
Ağırlık : 789 gr/m

⚠ İşaretti profil için satış ekibinden bilgi alınır.

ALUTECH COTTA
CEPHE SİSTEMİ PROFİLLERİ
FACADE SYSTEM PROFILE

ÜRÜN TEKNİK ÖZELLİKLERİ
PRODUCT'S TECHNICAL FEATURES

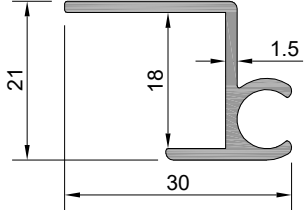

Profil No: COT-301
Ağırlık : 275 gr/m

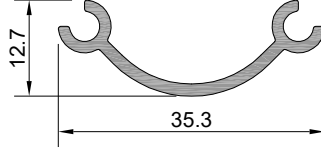

Profil No: COT-302
Ağırlık : 223 gr/m

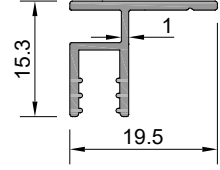

Profil No: COT-303
Ağırlık : 157 gr/m

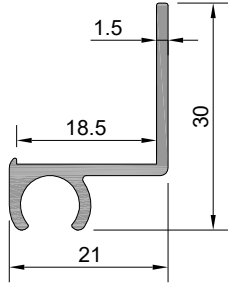

Profil No: COT-304
Ağırlık : 245 gr/m

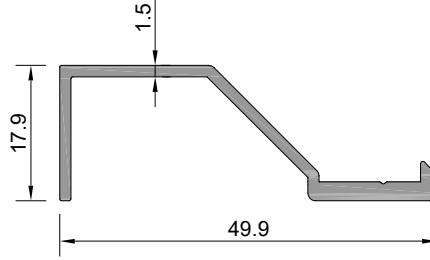

Profil No: COT-305
Ağırlık : 356 gr/m

ALUTECH COTTA
CEPHE SİSTEMİ PROFİLLERİ
FACADE SYSTEM PROFILE

ÜRÜN TEKNİK ÖZELLİKLERİ
PRODUCT'S TECHNICAL FEATURES

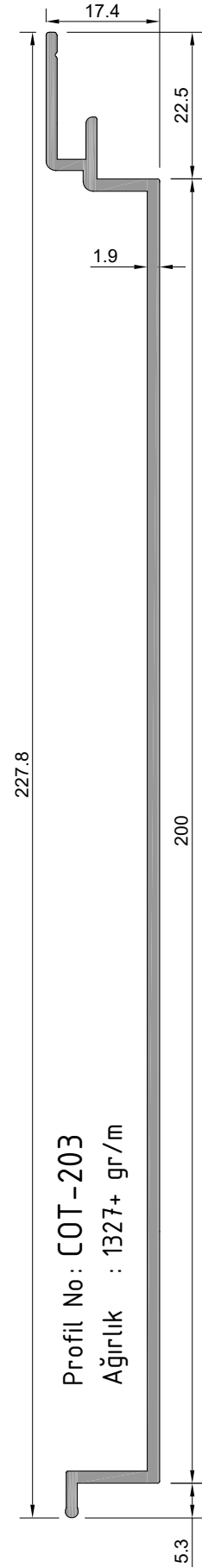
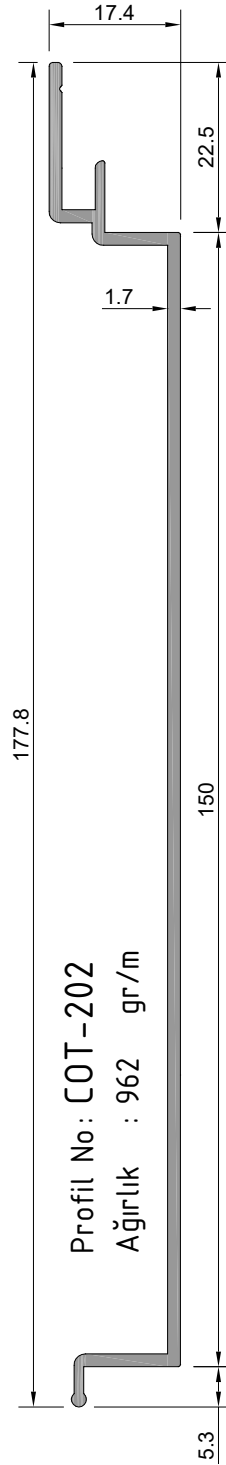
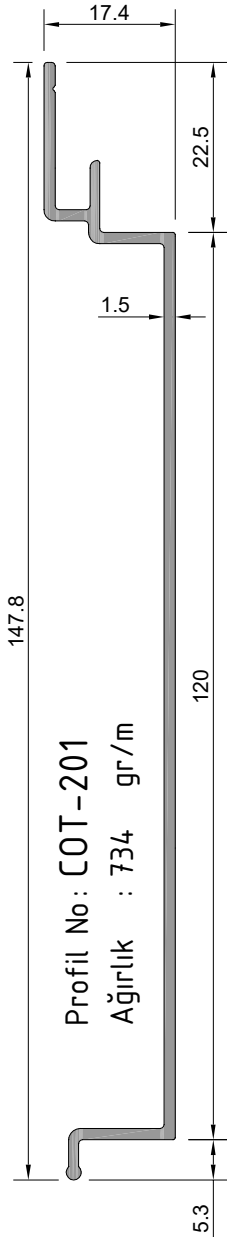

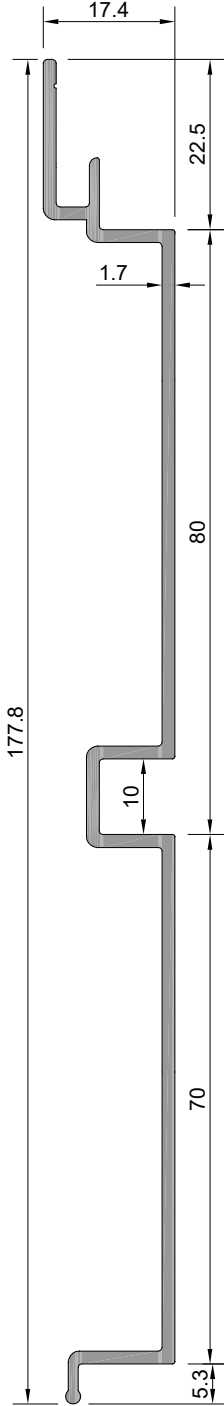

ALUTECH COTTA
CEPHE SİSTEMİ PROFİLLERİ
FACADE SYSTEM PROFILE

ÜRÜN TEKNİK ÖZELLİKLERİ
PRODUCT'S TECHNICAL FEATURES

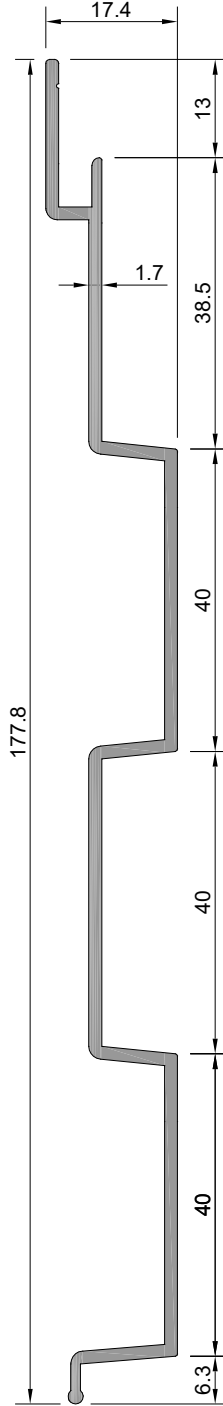

Profil No: COT-204
Ağırlık : 1053 gr/m



Profil No: COT-205 
Ağırlık : 1034 gr/m

 İşaretti profil için satış ekibinden bilgi alınız.

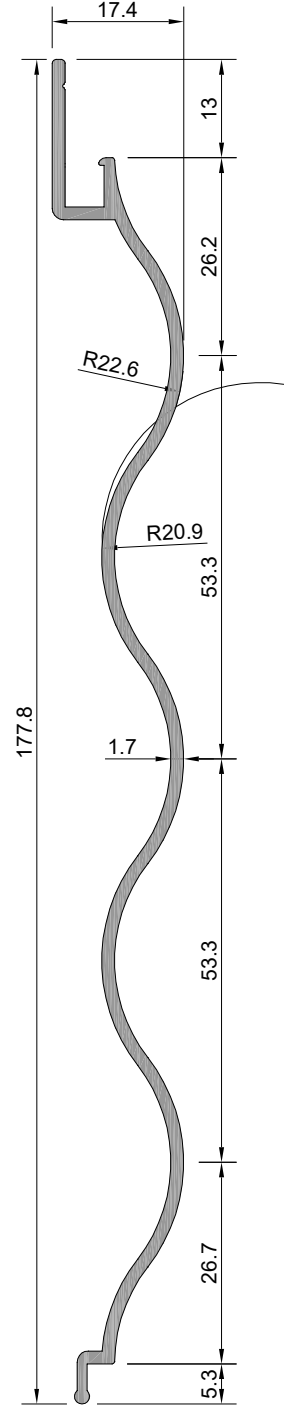

Profil No: COT-206
Ağırlık : 953 gr/m

ALUTECH COTTA
CEPHE SİSTEMİ PROFİLLERİ
FAÇADE SYSTEM PROFILE

ÜRÜN TEKNİK ÖZELLİKLERİ
PRODUCT'S TECHNICAL FEATURES

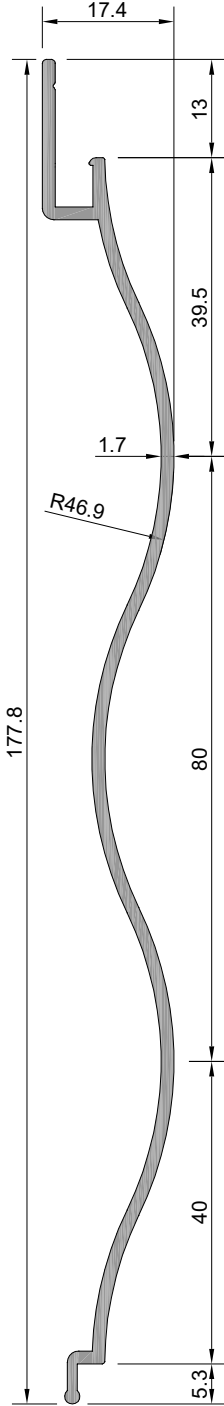

Profil No: COT-207
Ağırlık : 917 gr/m

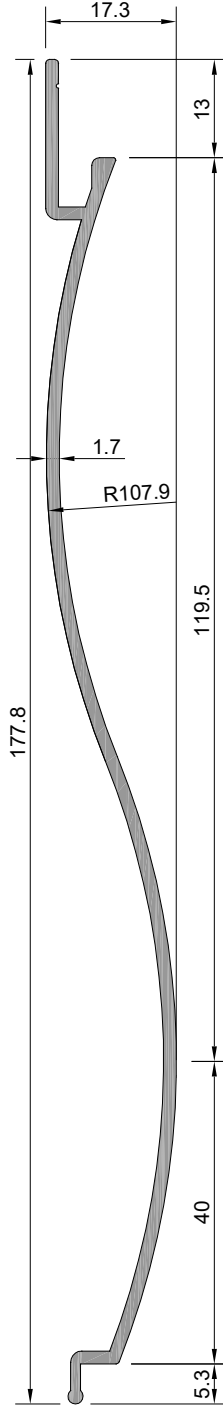

Profil No: COT-208 ⚠
Ağırlık : 912 gr/m

⚠ İşaretili profil için satış ekibinden bilgi alınır.

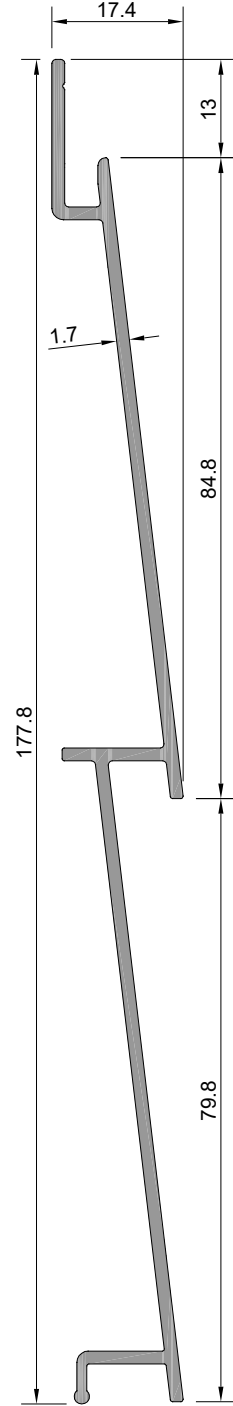

Profil No: COT-209
Ağırlık : 1038 gr/m

ALUTECH COTTA
CEPHE SİSTEMİ PROFİLLERİ
FACADE SYSTEM PROFILE

ÜRÜN TEKNİK ÖZELLİKLERİ
PRODUCT'S TECHNICAL FEATURES

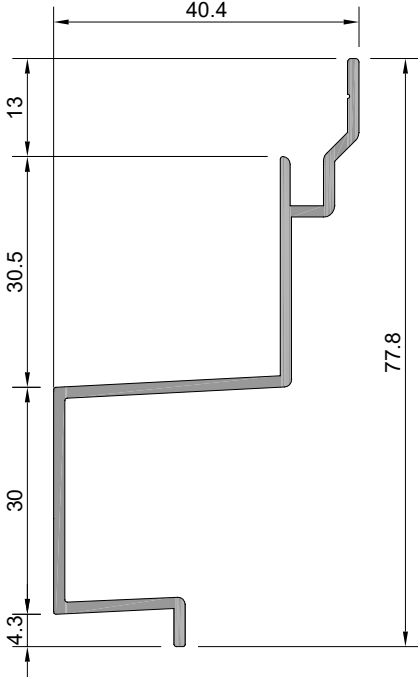

Profil No: COT-210
Ağırlık : 547 gr/m

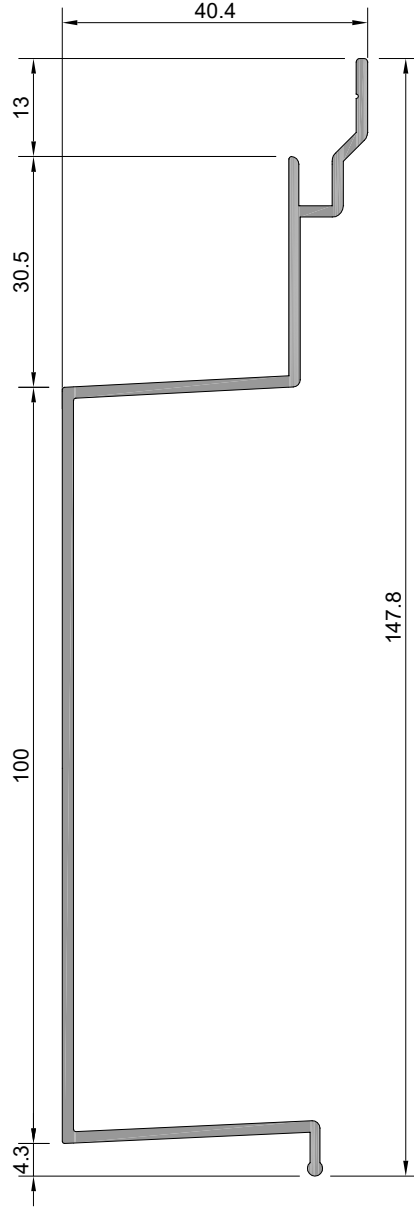

Profil No: COT-211
Ağırlık : 902 gr/m

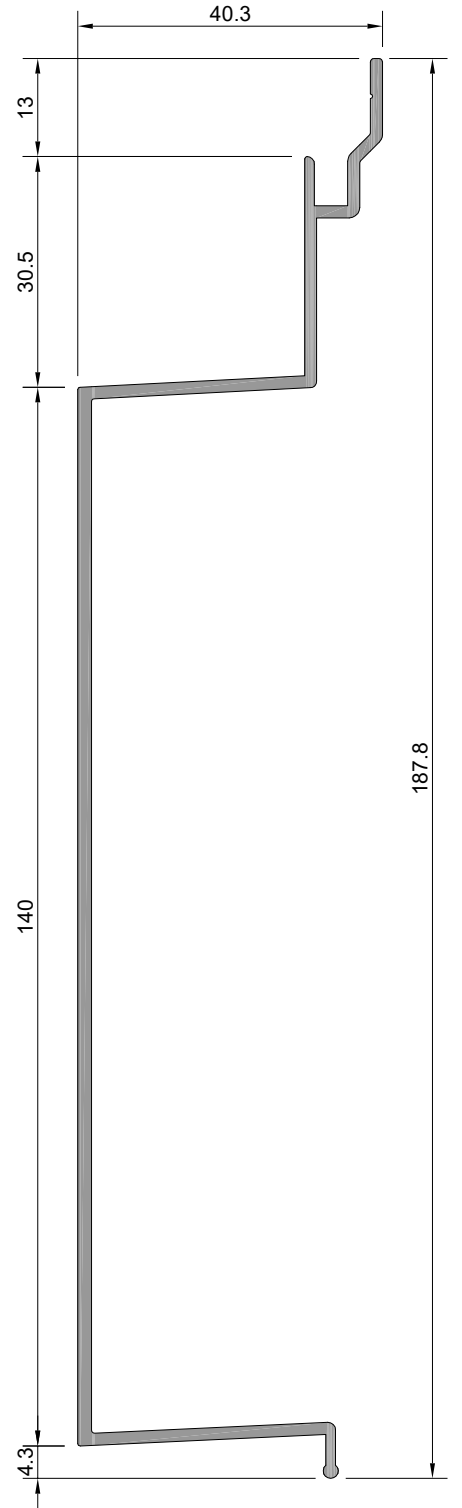

Profil No: COT-212
Ağırlık : 1206 gr/m

ALUTECH COTTA
CEPHE SİSTEMİ PROFİLLERİ
FAÇADE SYSTEM PROFILE

ÜRÜN TEKNİK ÖZELLİKLERİ
PRODUCT'S TECHNICAL FEATURES

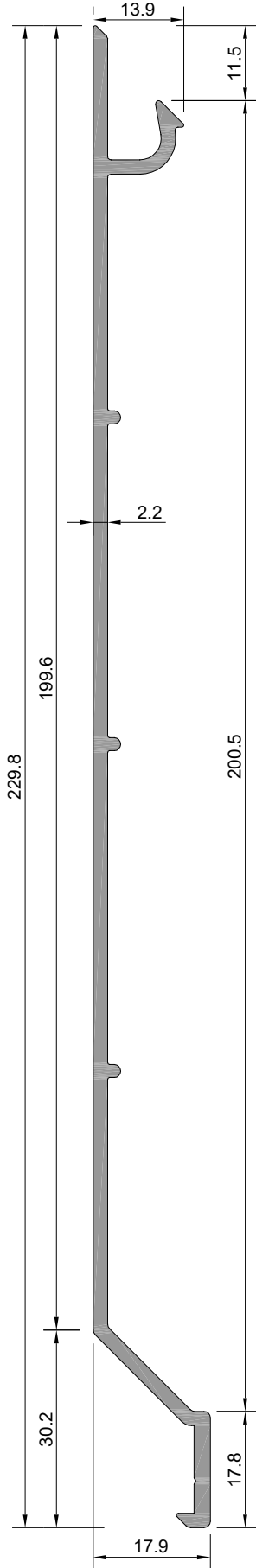

Profil No: COT-213
Ağırlık : 1572 gr/m

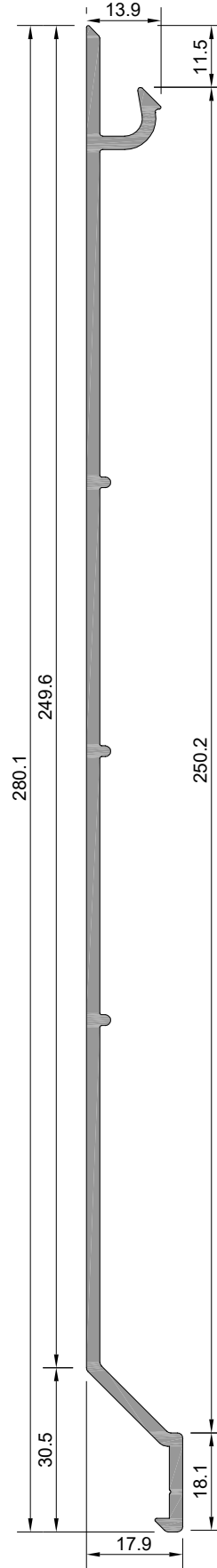

Profil No: COT-214 ⚠
Ağırlık : 2101 gr/m

⚠ İşaretili profil için satış ekibinden bilgi alınır.

ölçeksiz
not to scale

ALUTECH COTTA
CEPHE SİSTEMİ PROFİLLERİ
FACADE SYSTEM PROFILE

ÜRÜN TEKNİK ÖZELLİKLERİ
PRODUCT'S TECHNICAL FEATURES

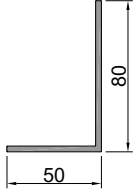

SER-301
Ağırlık:1032 gr/m

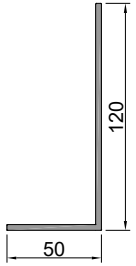
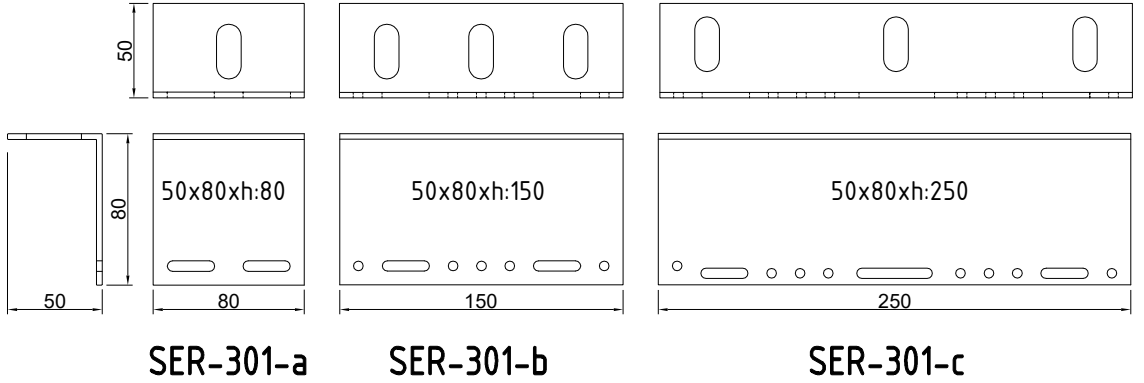

SER-302
ağırlık:1357 gr/m

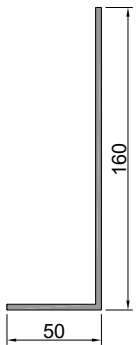
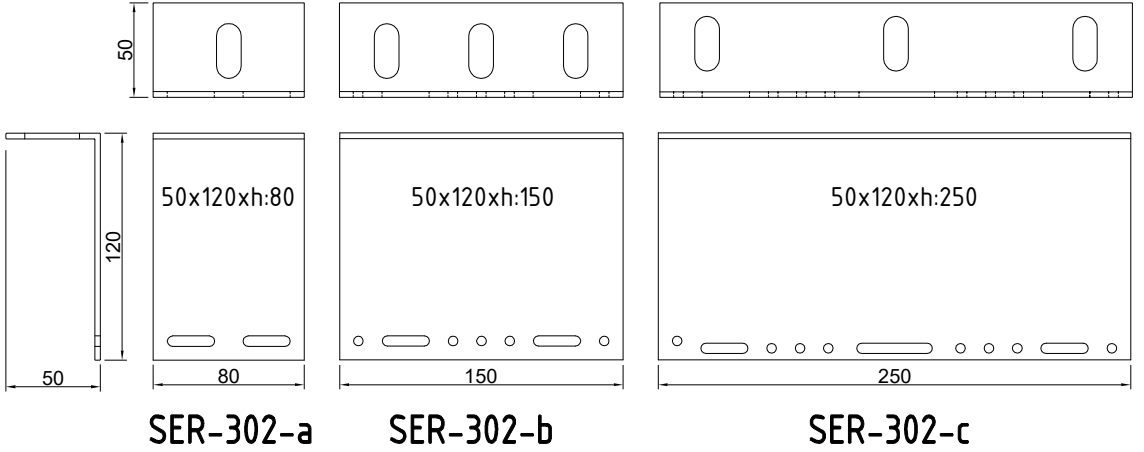

SER-303
ağırlık:1683 gr/m

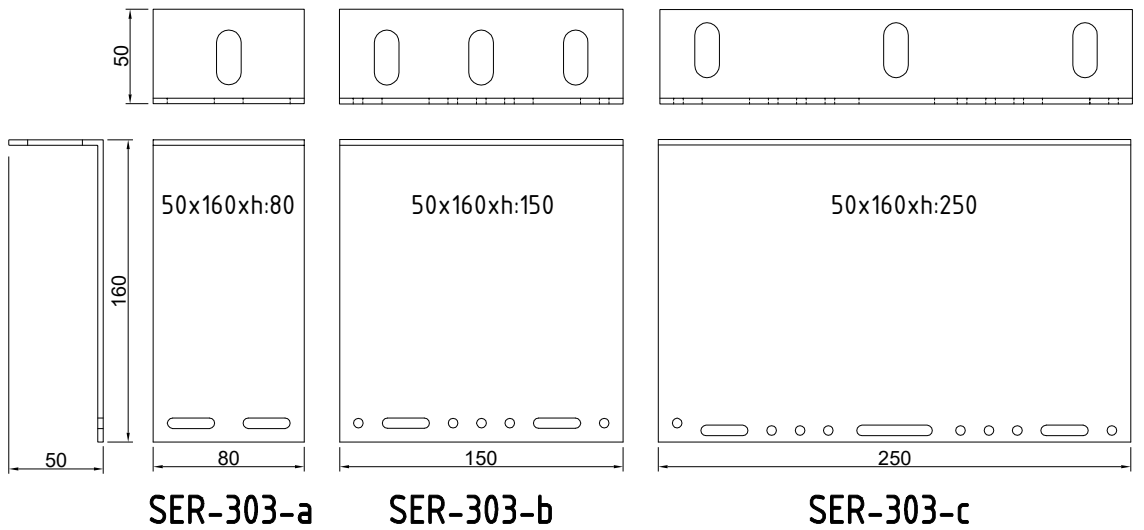

ALUTECH COTTA
CEPHE SİSTEMİ PROFİLLERİ
FACADE SYSTEM PROFILE

PLAN DETAY
PLAN DETAIL

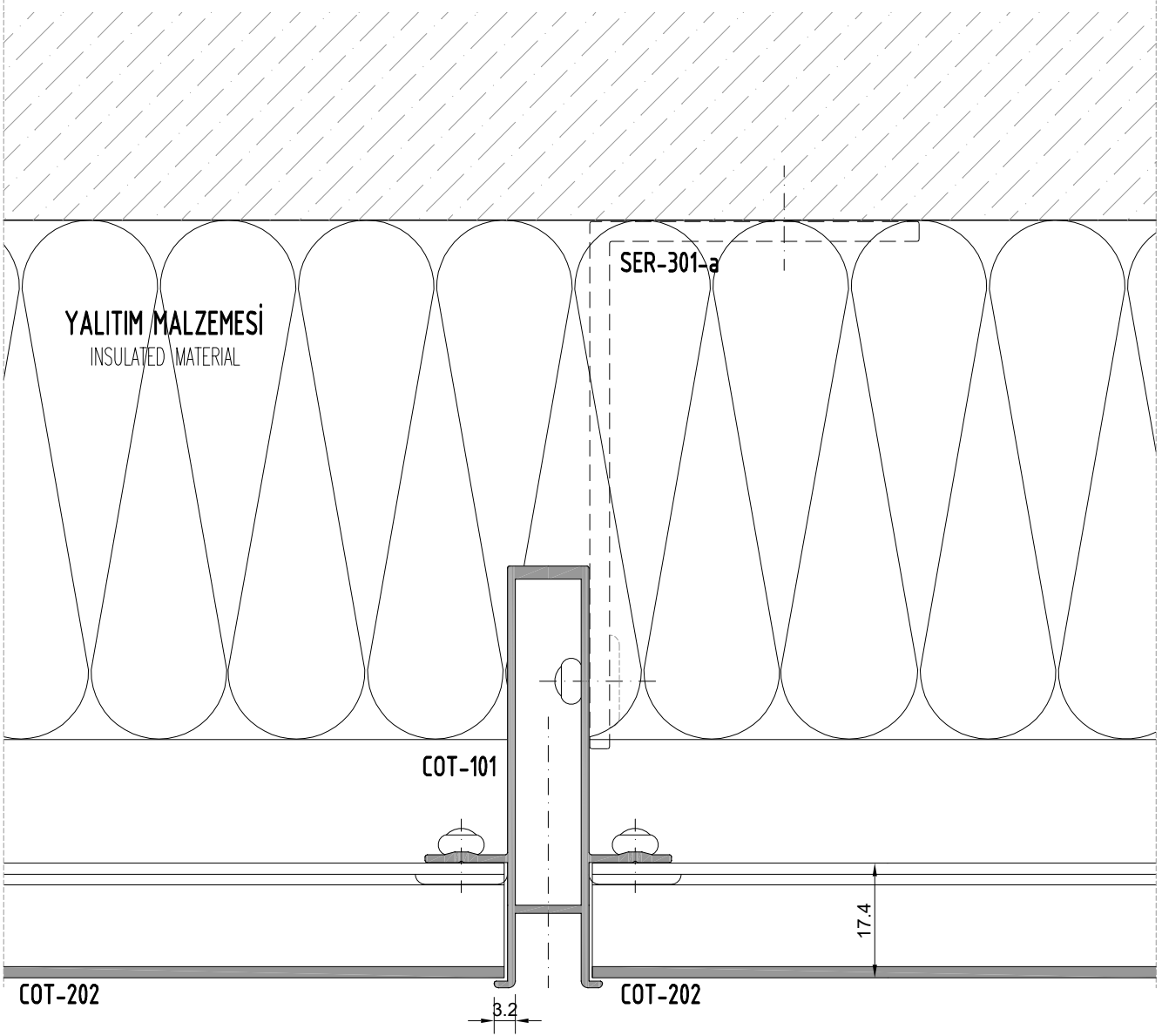

ALUTECH COTTA
CEPHE SİSTEMİ PROFİLLERİ
FACADE SYSTEM PROFILE

PLAN DETAY
PLAN DETAIL

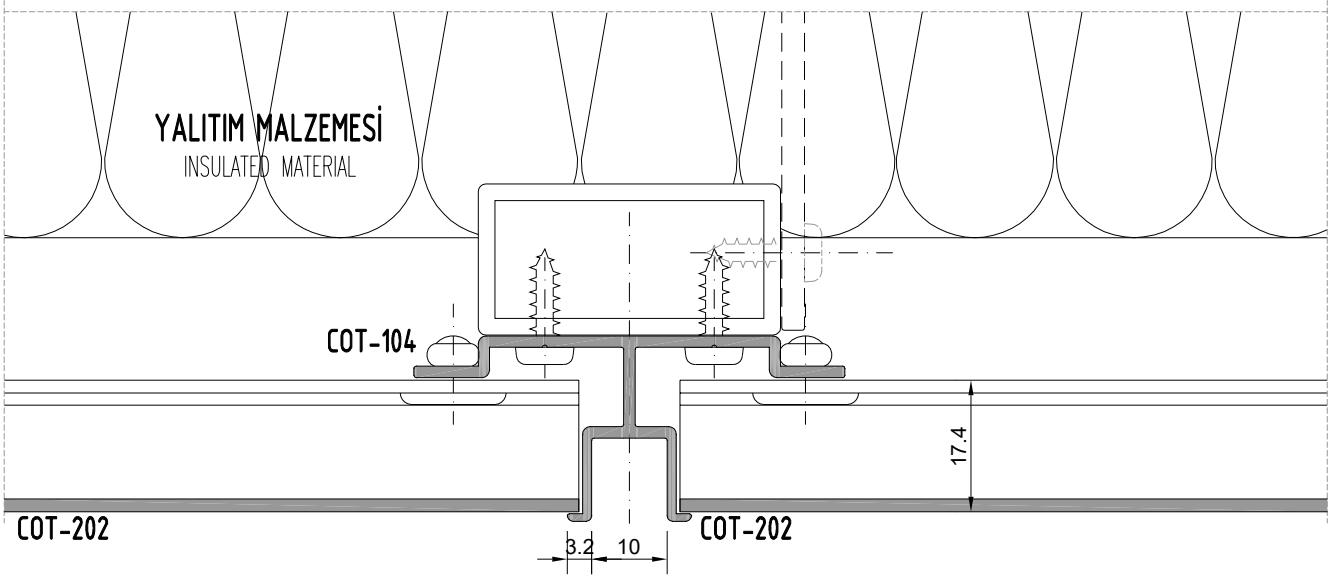
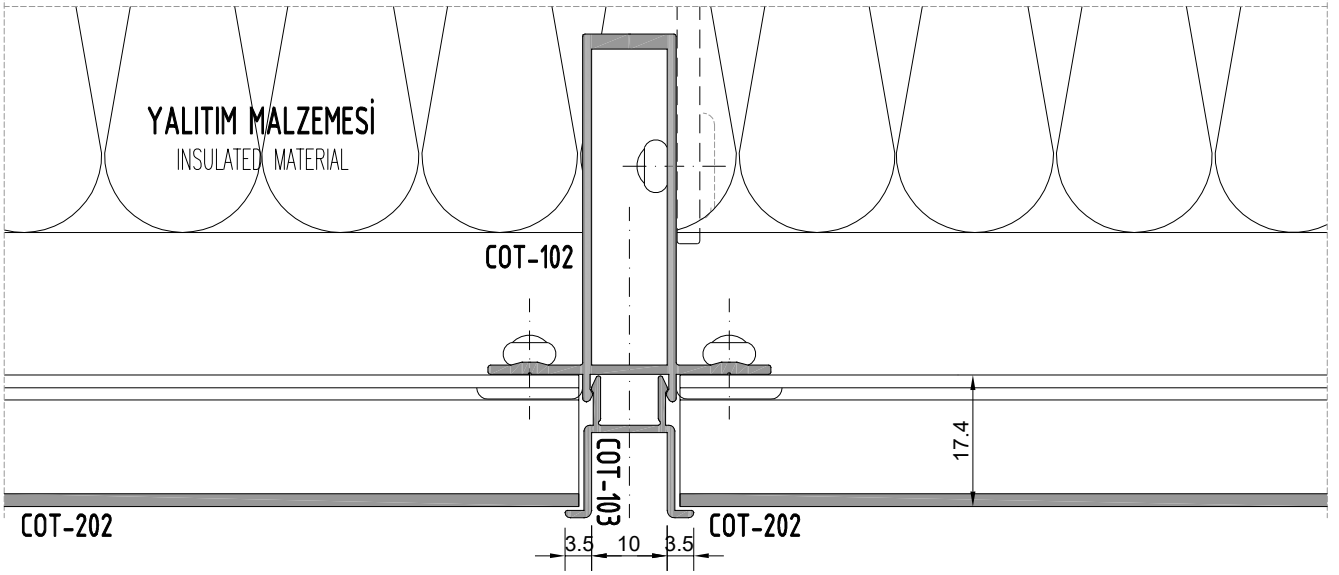

ALUTECH COTTA
CEPHE SİSTEMİ PROFİLLERİ
FACADE SYSTEM PROFILE

KÖŞE DETAY
CORNER DETAIL

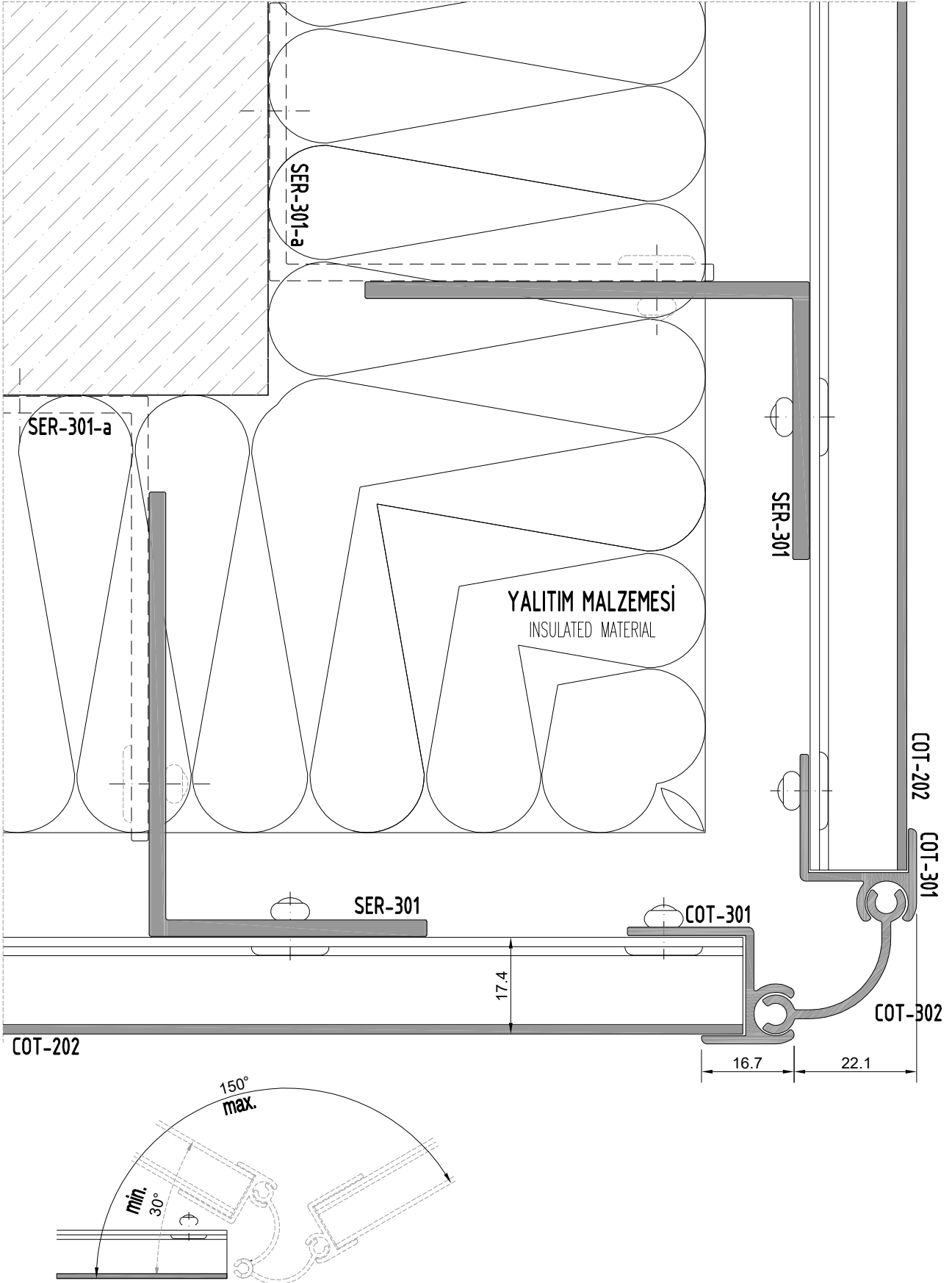

Profil değerleri teoriktir. Ağırlık olarak testimde yapılan tartım geçerlidir.
Profil imalatları TS EN 12020-2 ve TS EN 755-9 toleransı,
Moment değerleri EN 14024'e göre hesaplanmıştır.

Profile values are theoretical pre-shipment weight will be valid.
The tolerances of Profile manufacturing are calculated according to EN 12020-2
and TS EN 755-9; moment values are calculated according to EN 14024.

ALUTECH COTTA
CEPHE SİSTEMİ PROFİLLERİ
FACADE SYSTEM PROFILE

KÖŞE DETAY
CORNER DETAIL

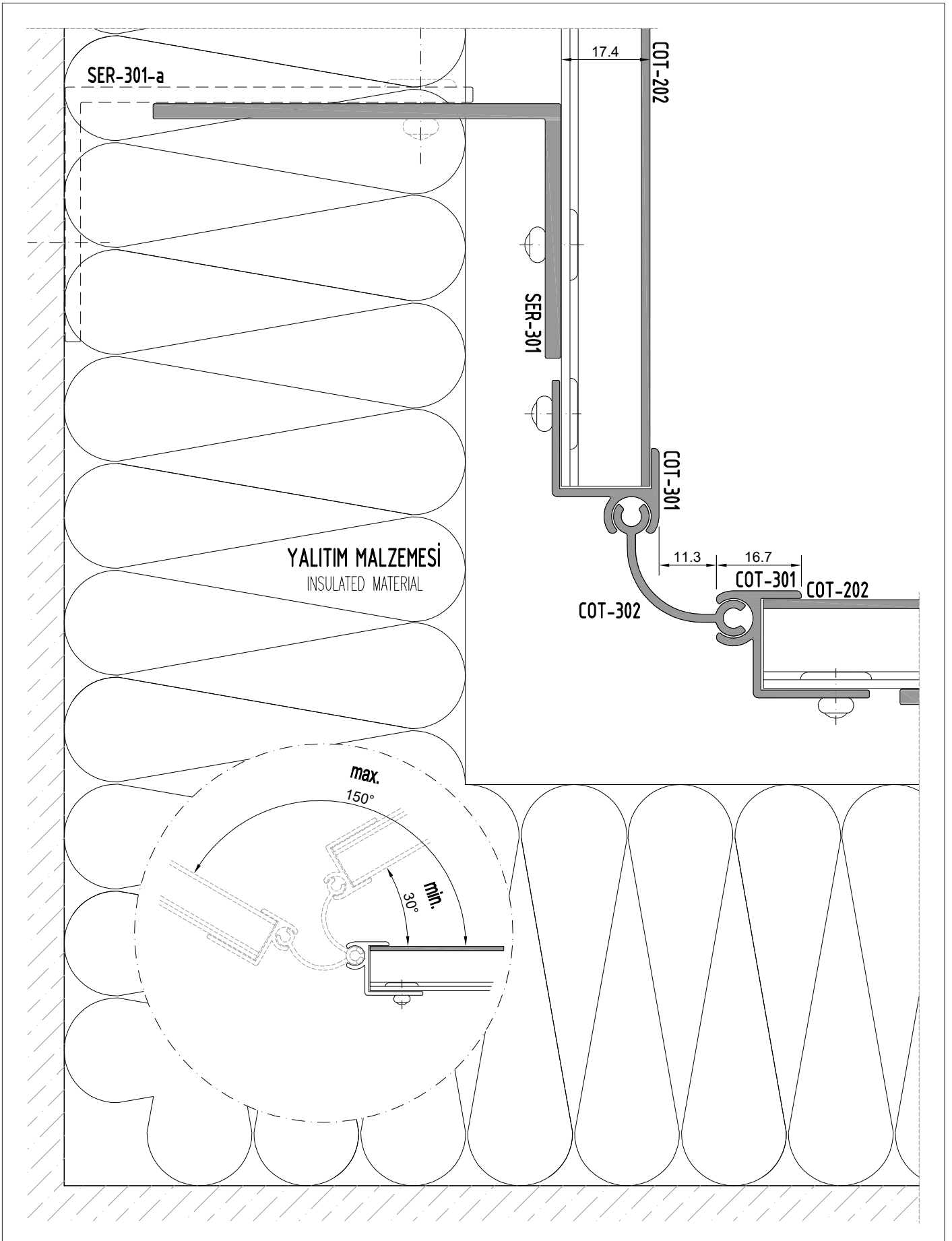

Profil değerleri teoriktir. Ağırlık olarak testimde yapılan tartım geçerlidir.
Profil imalatları TS EN 12020-2 ve TS EN 755-9 toleransı,
Moment değerleri EN 14024'e göre hesaplanmıştır.

Profile values are theoretical pre-shipment weight will be valid.
The tolerances of Profile manufacturing are calculated according to EN 12020-2
and TS EN 755-9; moment values are calculated according to EN 14024.

ALUTECH COTTA
CEPHE SİSTEMİ PROFİLLERİ
FACADE SYSTEM PROFILE

KESİT DETAY
SECTION DETAIL

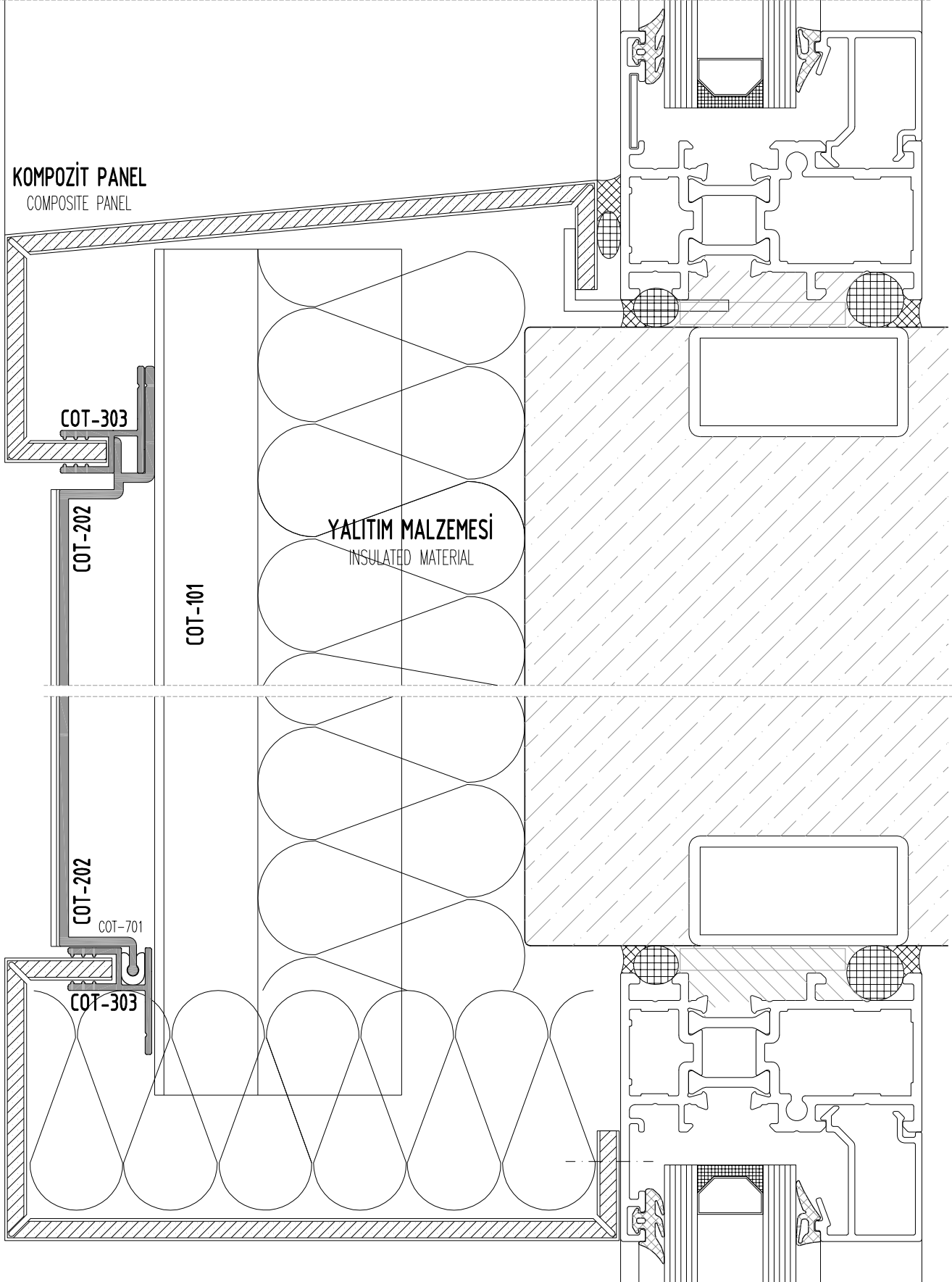

Profil değerleri teoriktir. Ağırlık olarak testimde yapılan tartım geçerlidir.
Profil imalatları TS EN 12020-2 ve TS EN 755-9 toleransı,
Moment değerleri EN 14024'e göre hesaplanmıştır.

Profile values are theoretical pre-shipment weight will be valid.
The tolerances of Profile manufacturing are calculated according to EN 12020-2
and TS EN 755-9; moment values are calculated according to EN 14024.

ALUTECH COTTA
CEPHE SİSTEMİ PROFİLLERİ
FACADE SYSTEM PROFILE

KESİT DETAY
SECTION DETAIL

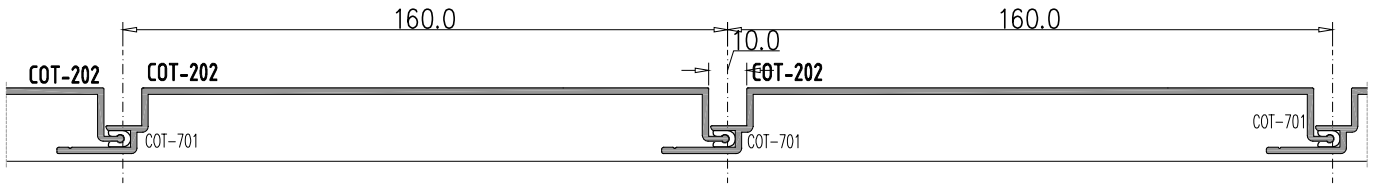
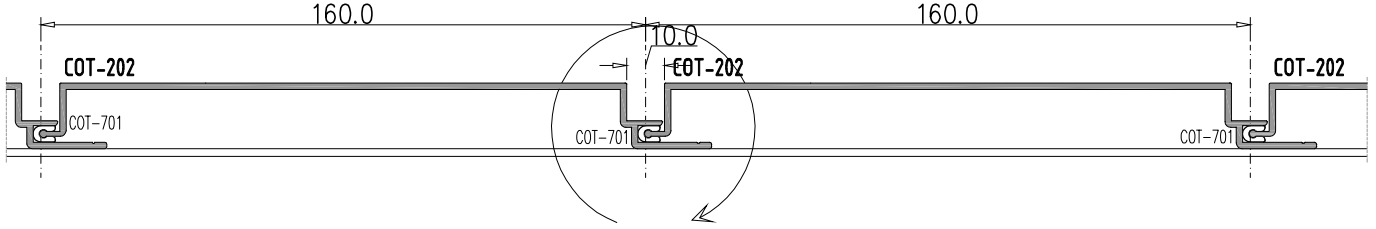

TERS MONTAJ YAPILABİLİR
CONVERSELY CAN BE MOUNTED

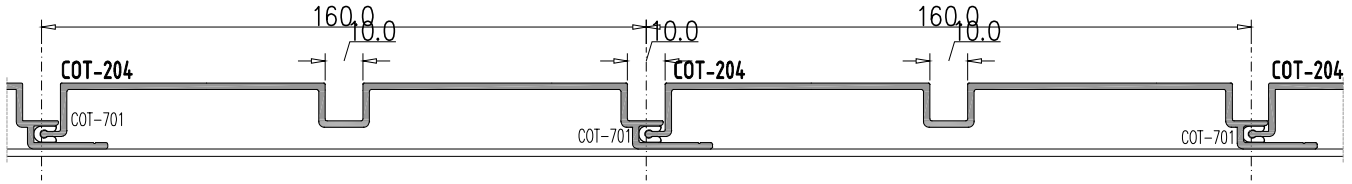

TERS MONTAJ YAPILABİLİR
CONVERSELY CAN BE MOUNTED

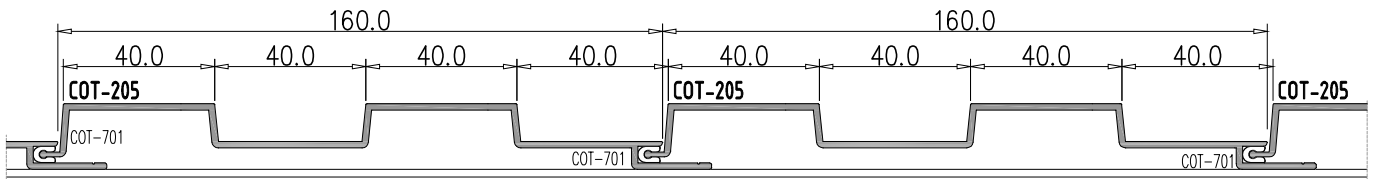

TERS MONTAJ YAPILABİLİR
CONVERSELY CAN BE MOUNTED

ALUTECH COTTA
CEPHE SİSTEMİ PROFİLLERİ
FACADE SYSTEM PROFILE

KESİT DETAY
SECTION DETAIL

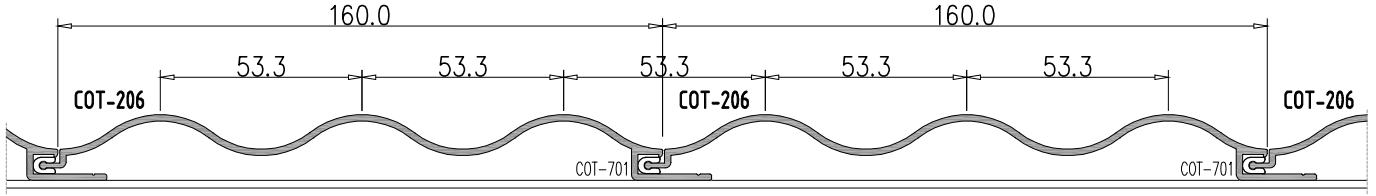

TERS MONTAJ YAPILABİLİR
CONVERSELY CAN BE MOUNTED

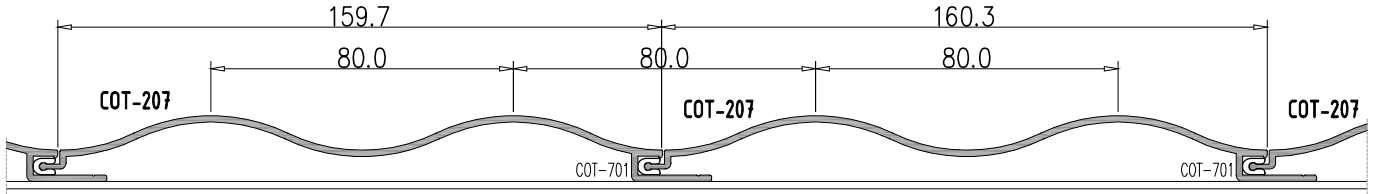

TERS MONTAJ YAPILABİLİR
CONVERSELY CAN BE MOUNTED

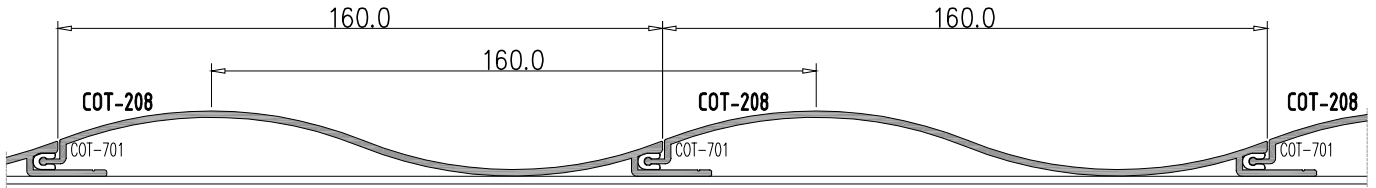

TERS MONTAJ YAPILABİLİR
CONVERSELY CAN BE MOUNTED

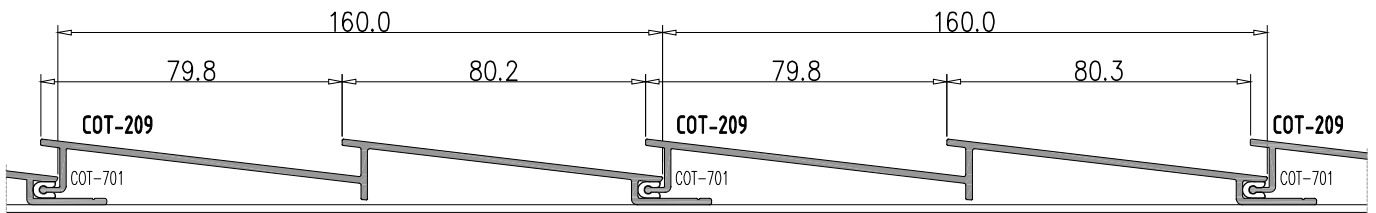

TERS MONTAJ YAPILABİLİR
CONVERSELY CAN BE MOUNTED

ALUTECH COTTA
CEPHE SİSTEMİ PROFİLLERİ
FACADE SYSTEM PROFILE

KESİT DETAY
SECTION DETAIL

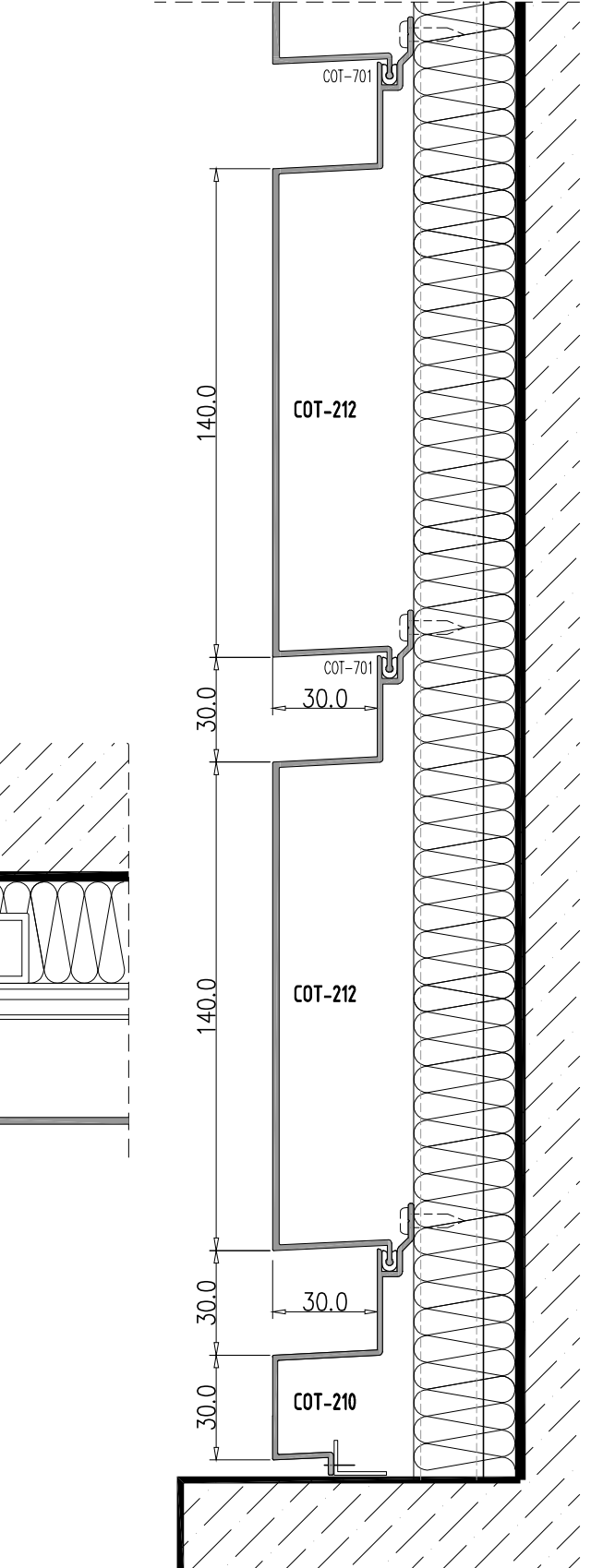
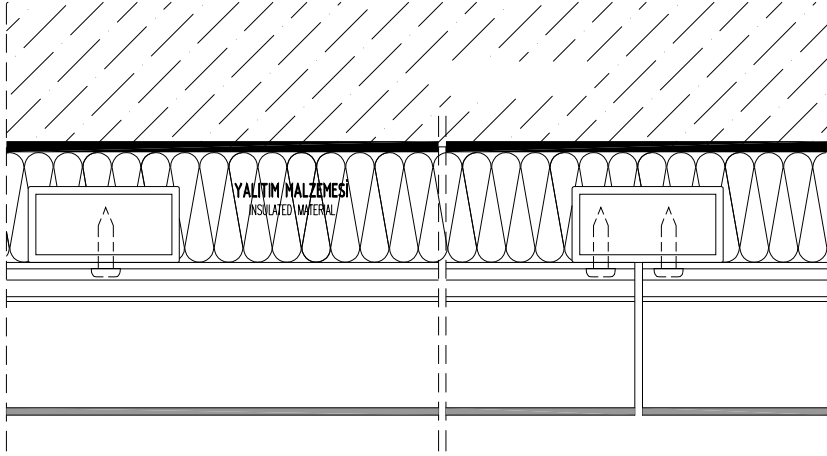

ALUTECH COTTA
CEPHE SİSTEMİ PROFİLLERİ
FAÇADE SYSTEM PROFILE

KÖŞE DETAY
CORNER DETAIL

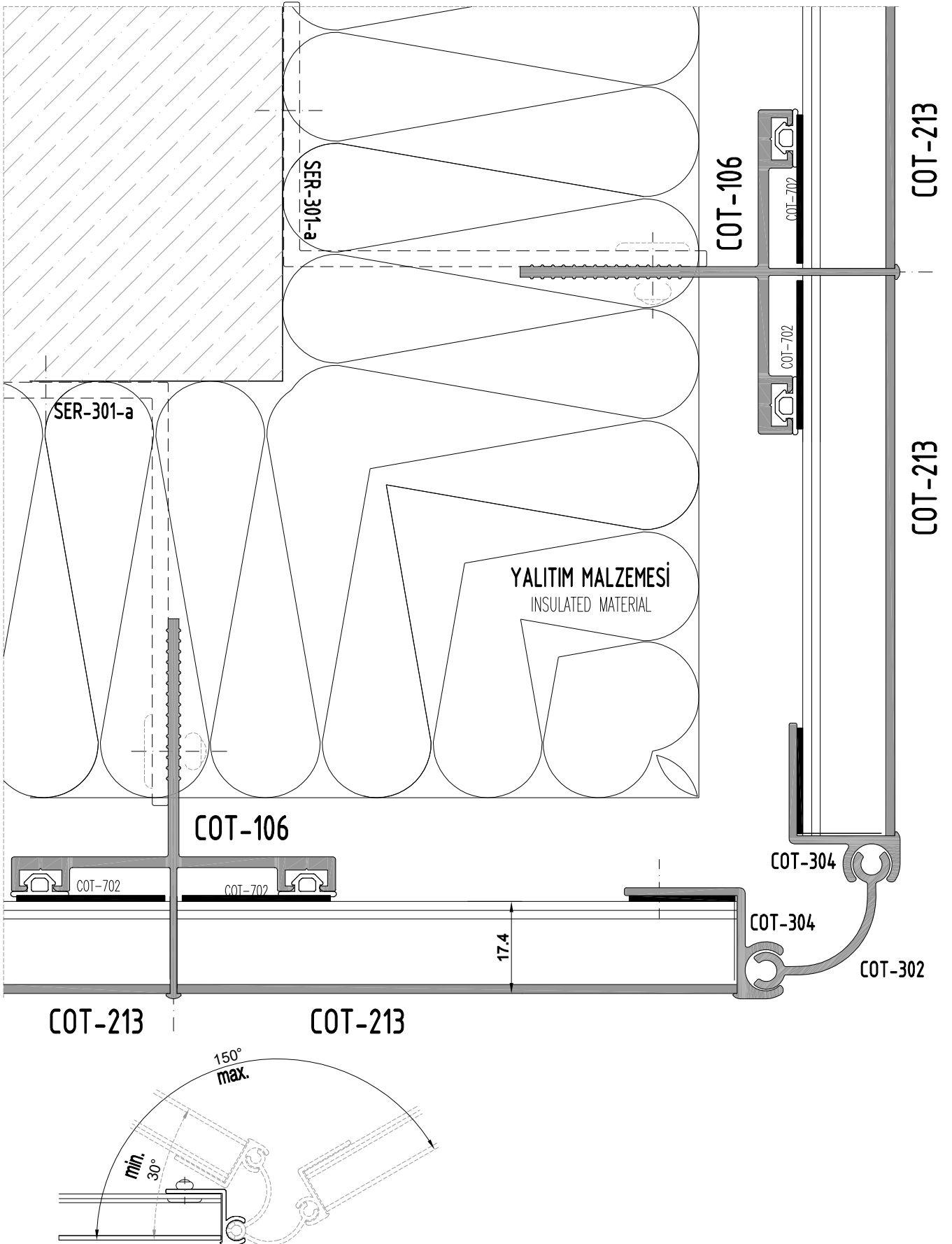

Profil değerleri teoriktir. Ağırlık olarak testimde yapılar tartım geçerlidir.
Profil imalatları TS EN 12020-2 ve TS EN 755-9 toleransı,
Moment değerleri EN 14024'e göre hesaplanmıştır.

Profile values are theoretical. Moment values will be valid.
the measured weight, tolerances and moment values will be valid.
The tolerances of Profile manufacturing are calculated according to EN 12020-2
and TS EN 755-9; moment values are calculated according to EN 14024.

ALUTECH COTTA
CEPHE SİSTEMİ PROFİLLERİ
FACADE SYSTEM PROFILE

KÖŞE DETAY
CORNER DETAIL

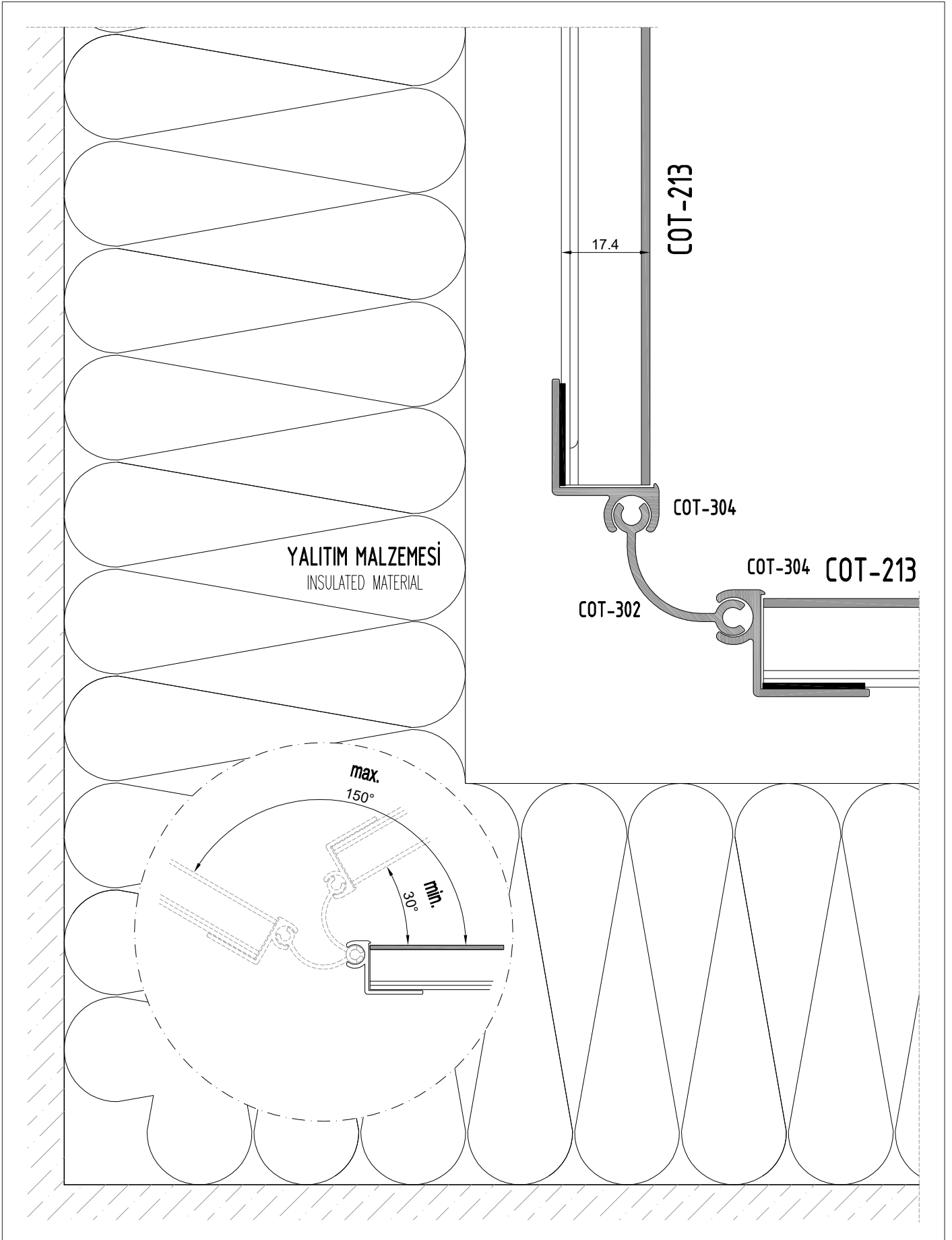

Profil değerleri teoriktir. Ağırlık olarak teslimde yapılar tartım geçerlidir.
Profil imalatları TS EN 12020-2 ve TS EN 755-9 toleransı,
Moment değerleri EN 14024'e göre hesaplanmıştır.

Profile values are theoretical and moment values will be valid.
the measured weight for shipping and installation will be valid.
The tolerances of Profile manufacturing are calculated according to EN 12020-2
and TS EN 755-9; moment values are calculated according to EN 14024.

ALUTECH COTTA
CEPHE SİSTEMİ PROFİLLERİ
FACADE SYSTEM PROFILE

KESİT DETAY
SECTION DETAIL

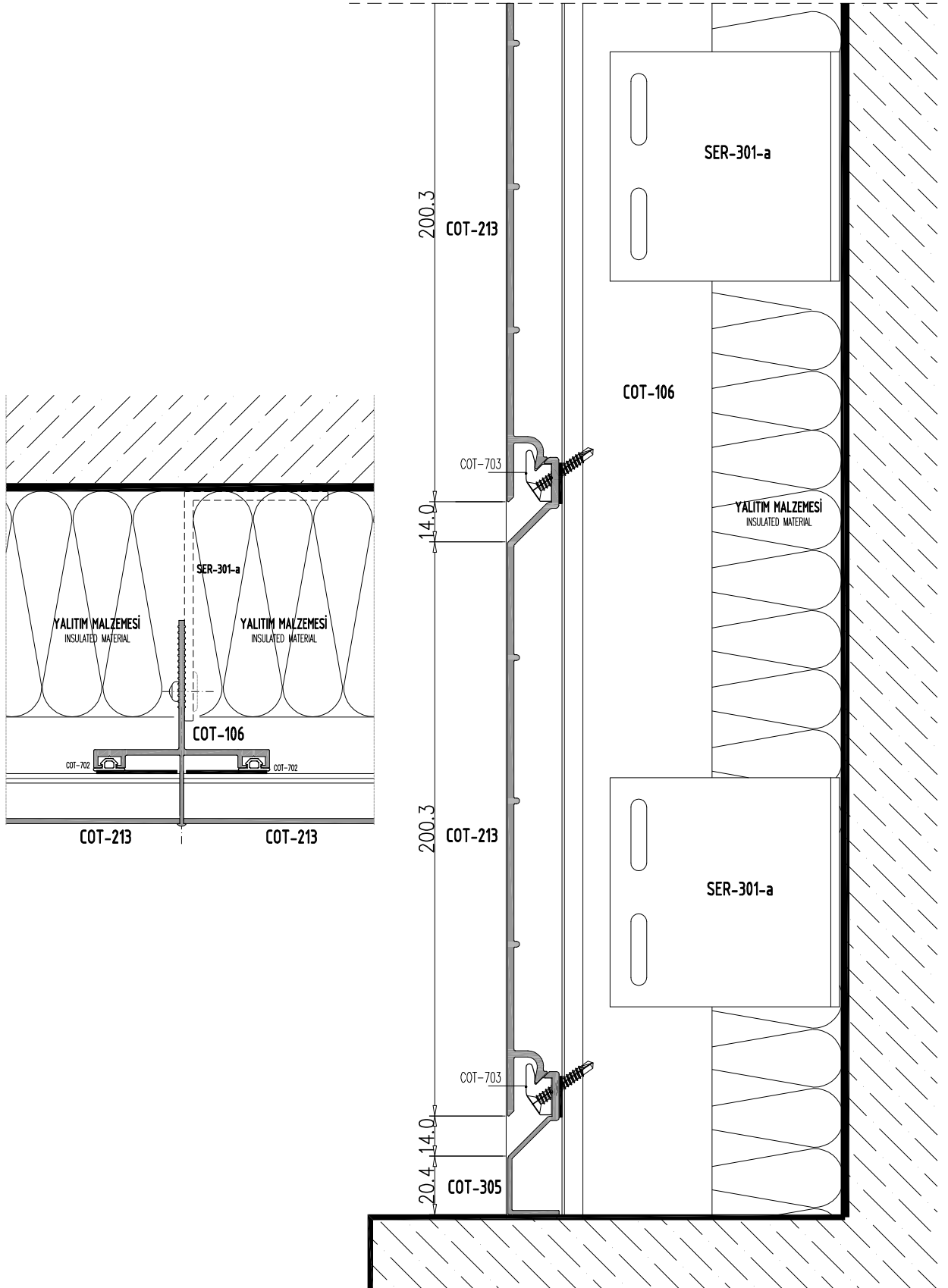

Profil değerleri teoriktir. Ağırlık olarak testimde yapılar tartım geçerlidir.
Profil imalatları TS EN 12020-2 ve TS EN 755-9 toleransı,
Moment değerleri EN 14024'e göre hesaplanmıştır.

Profile values are theoretical, shipment weight will be valid.
The measured weight before shipment is valid, not shipment weight.
The tolerances of Profile manufacturing are calculated according to EN 12020-2
and TS EN 755-9; moment values are calculated according to EN 14024.

